

# tab Express

File Folders / Folder Accessories / Labels / Indexes / Pockets / File Labeling Software

## *Customize* your folders!

NEW *short run custom* printing  
PLUS, *custom* dividers  
ALSO, *custom* printed labels  
And, *custom* indexes & filebacks



*Catalog includes AMES Medical Office Supplies.*

2024 CATALOG  
shoptab.com | 888-822-9777



# Find your file folders, filing labels, pockets and more at [shoptab.com](https://shoptab.com)

Have you had a chance to order products on our new and improved ecommerce site, [shoptab.com](https://shoptab.com)? You can place orders for the products your organization uses today – on a faster more streamlined platform.

We updated the code to make the site faster and shopping easier, plus we added our AMES branded medical office filing supplies to the platform.

## What you'll find when you order online at [shoptab.com](https://shoptab.com):

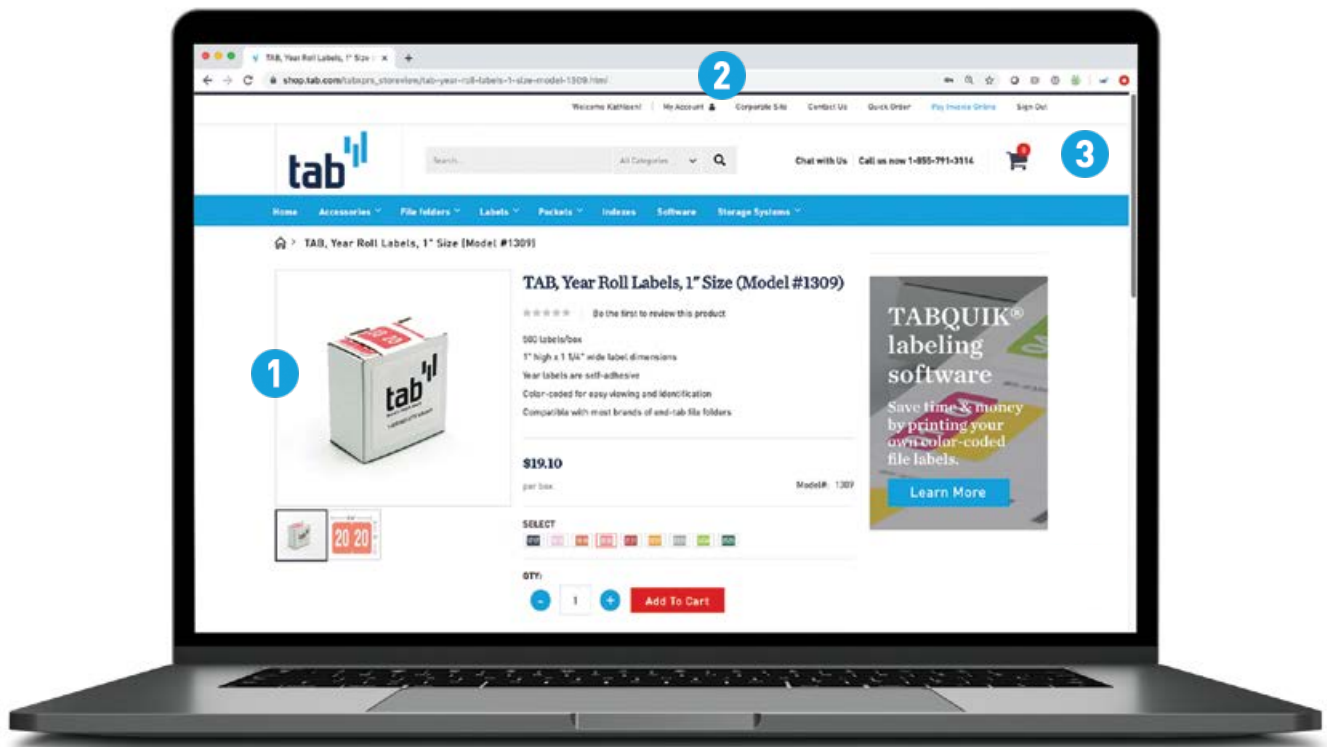

- 1 High-quality product photographs and detailed descriptions so you know exactly what you're getting
- 2 Self-service account management so you may update your address, account information and quickly re-order frequently used products
- 3 Streamlined 2-step order process with shipping and tax estimates available at time of checkout

We know this improved shopping site will be another way TAB helps you organize, access and store your physical files.

Visit our store at [shoptab.com](https://shoptab.com) to create an account today!

# TABQUIK®



Save time and money by printing your own color-coded file labels.

## Why TABQUIK?

### TABQUIK is easy.

Print labels in three simple steps: select the design, enter or import your data, and click “print”.

### TABQUIK is flexible.

It runs on any internet-connected computer with any popular browser and a standard color office printer.

### TABQUIK is secure.

Sensitive data never leaves your computer.

### TABQUIK Features:

- Color-match letters or numbers to any popular labeling system
- Print text such as names or account numbers on both sides of the label, for quick identification.
- Use highlights to emphasize important text print color bands or year codes to quickly identify specific types of files
- Automatically generate barcodes for file tracking

## Learn more:

888-466-8228  
tabquik.com

## Table of Contents

### Folders

Manila .....	8
Color and Color Stripe .....	9-11

### Pressboard Folders

Expansion .....	12-14
Classification .....	13-14

### Custom Options

Fasteners .....	15-16
Pockets .....	17
Printing and Dividers .....	18

### Pockets

Manila and Color Stripe .....	19
Color One Piece and Slash-Cut .....	20
Dental Patient and Full Pocket .....	20
Red Rope and Color Expansion .....	21-22

### Health Care

X-Ray Jackets .....	23-24
X-Ray Mailer .....	25
X-Ray Category Inserts .....	25

### Indexes

Health Care Title Sets .....	25
Custom Indexes & Filebacks .....	26
Stock Dividers & Filebacks .....	27-28

### Labels

Alphabetic .....	30-33
Numeric .....	34-37
Top Tab .....	38
Solid Color .....	39
Accessories & Custom Labels .....	40
Month/Year .....	41-43
TABQUIK .....	44

### Outguides

Vinyl and In-Sight .....	45
Center and Bottom-Tab, plus Folder Repair Strips .....	46

**Terms & Policies** ..... 47

**Index** ..... 48-49

**Easy Order Planner** ..... 50

## Please visit:

[www.shoptab.com](http://www.shoptab.com)  
to see our latest pricing

# Manila Folders

## Standard

TAB's standard folders are designed to provide an inch of space in both paper dimensions insuring that your important documents are protected from wear and tear in file or out. The double-ply side tab provides extra strength where other folders often break down.

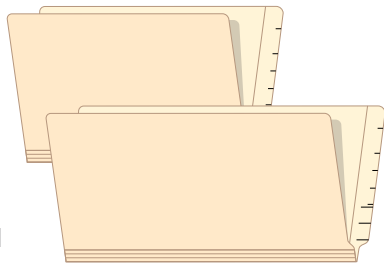

## Letter – Standard

MODEL	DESCRIPTION	QUANTITY
1103-50	11 pt. Double Ply	box of 100
1123-00	14 pt. Double Ply	box of 50
1102-00	11 pt. Single Ply	box of 100
1128-00	14 pt. Single Ply	box of 50
1141-00	18 pt. Single Ply	box of 50



## Legal – Standard

MODEL	DESCRIPTION	QUANTITY
1105-50	11 pt. Double Ply	box of 100
1127-00	14 pt. Double Ply	box of 50
1104-00	11 pt. Single Ply	box of 100
1118-00	14 pt. Single Ply	box of 50
1142-00	18 pt. Single Ply	box of 50

## Short Body

Need to store your folders in a drawer as well as on a shelf? Our short body folder (Length reduced by 1/4") has a space provided on the top back panel to attach a label for quick identification.

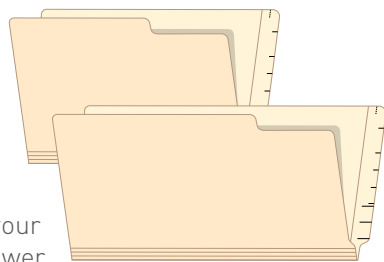

## Letter – Short Body

MODEL	DESCRIPTION	QUANTITY
1317-00	11 pt. Double Ply	box of 100
1318-00	14 pt. Double Ply	box of 50



## Legal – Short Body

MODEL	DESCRIPTION	QUANTITY
1327-00	11 pt. Double Ply	box of 100
1328-00	14 pt. Double Ply	box of 50

## 2TAB

Full length top and side tabs allow for color coding labels to be applied in both locations. And with its reduced length (1/4") it fits safely into a drawer or a shelf.

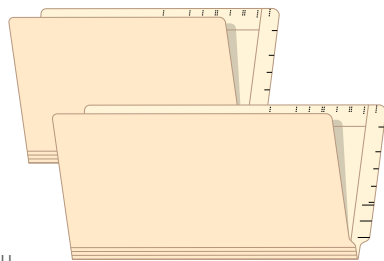

## Letter – 2TAB

MODEL	DESCRIPTION	QUANTITY
1344-00	11 pt. 2TAB	box of 100
1345-00	14 pt. 2TAB	box of 50



## Legal – 2TAB

MODEL	DESCRIPTION	QUANTITY
1346-00	11 pt. 2TAB	box of 50
1347-00	14 pt. 2TAB	box of 50

11 pt. is double-ply top and side tabs. 14 pt. is single-ply top tab and double-ply side tab.

## Half Cut (Lower/Upper) Manila Folders

Letter size 11 pt. manila double-ply folder with 4" side tab. Ideal application for numbering on tab.

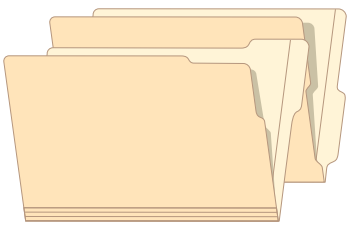

MODEL	DESCRIPTION	QUANTITY
4354-50	Lower position tab	box of 100
4357-13	Upper position tab	box of 100

# Manila Folders

## Manila and Lavender – Double Side Tab Folders

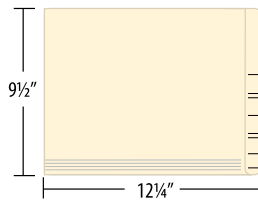
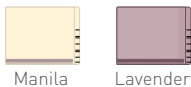
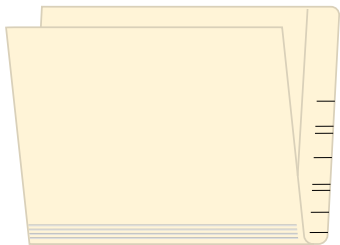

### Letter

MODEL	DESCRIPTION	QUANTITY
5260-0T	14pt Lavender, Eternafilm reinforced	box of 50
5050-0T	11pt Lavender	box of 50
5050-00	11pt Manila	box of 50
5150-00	14pt Manila	box of 50

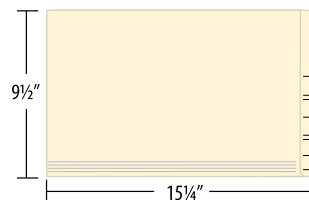

### Legal

MODEL	DESCRIPTION	QUANTITY
5100-0T	11pt Lavender	box of 50
5100-00	11pt Manila	box of 50

## AMES DuraTab Reinforced Folders

AMES 11 point and 14 point manila folders come with DuraTab interlocking double reinforced top and side tabs that stand up to frequent use.

- Side tab folders are designed for open shelf filing and feature outline blocks on the tabs for optional color-coded tapes.
- Folders are scored above the fold for self expansion.

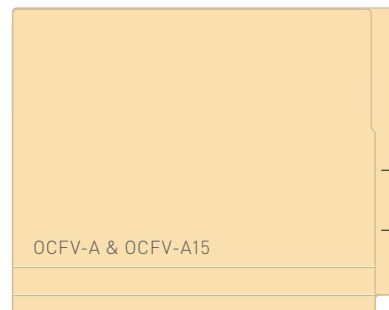

To Order Custom Imprint  
Call 1.888.822.9777.

## Self-Expansion Manila Folders

MODEL	DESCRIPTION	SIZE	LBS./BOX	QUANTITY
OCFV-A	11 pt., side tab	9-1/2" x 12-1/8"	46 lbs.	box of 500
OCFV-A15	14 pt., side tab	9-1/2" x 12-1/8"	32 lbs.	box of 250

## AMES Standard Reinforced Folders with Fasteners

AMES standard manila folders with fasteners come with DuraTab interlocking double reinforced top and side tabs for added durability and strength.

- Overall size: 9-1/2" x 12-1/8".
- Available in 11 point manila stock.
- Choose one or two 2" bonded fasteners.
- Folders are scored above the fold for self expansion.

MODEL	DESCRIPTION	SIZE	LBS./BOX	QUANTITY
OCFV-1P	11 pt., 1 fastener	9-1/2" x 12-1/8"	50 lbs.	box of 250
OCFV-2P	11 pt., 2 fasteners	9-1/2" x 12-1/8"	52 lbs.	box of 250

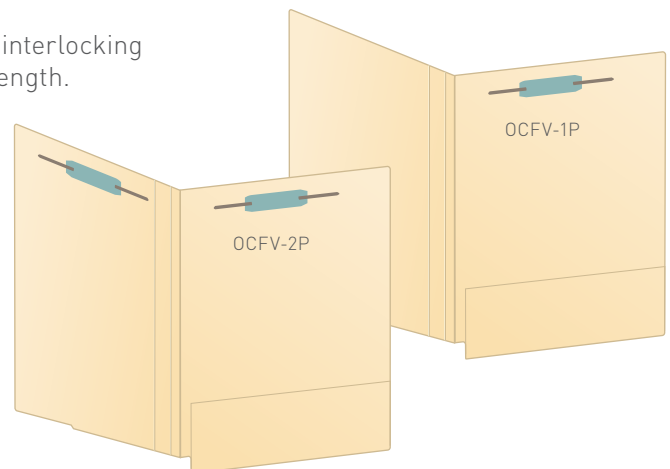

# Manila Folders

## Easiclip Folders

Easiclip folders give you the same accessibility as 3-ring binders, while saving you more shelf space.

- Overall size: 9-1/2" x 12-1/8", including a 3/4" side tab.
- Choose 11 point or 15 point manila stock.
- Folders are scored above the fold for self expansion.
- Easiclips come factory-attached to the folders in position 5 (shown right).

ITEM NO.	DESCRIPTION	LBS./BOX	QUANTITY
OCFV-EZ	11 point	28 lbs.	\$ 382.50/box
OCFV-EZ-15	15 point	38 lbs.	\$ 427.50/box

To Order Custom Imprint Call 1.888.822.9777.

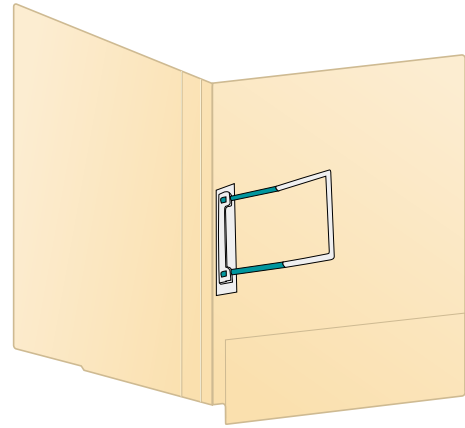

## Side-Reinforced Folders

Affordable side-reinforced manila folders available in 11 or 15 point stock.

- Overall size: 9-1/2" x 12-3/16".
- 2-1/16" reinforced side tab.
- Folders are scored above the fold for self expansion.



ITEM NO.	DESCRIPTION	LBS./BOX	QUANTITY
LI-FLD11	11 pt. folder	45 lbs.	box of 500
LI-FLD15	15 pt. folder	30 lbs.	box of 250

To Order Custom Imprint Call 1.888.822.9777.

## Side-Reinforced Folders with Fasteners

11 or 15 point side-reinforced manila folders with 2" fasteners.

- Overall size: 9-1/2" x 12-3/16".
- 2-1/16" reinforced side tab.
- Choose one 2" bonded fastener in position 1 or two 2" bonded fasteners in positions 1 and 3.
- Folders are scored above the fold for self expansion.

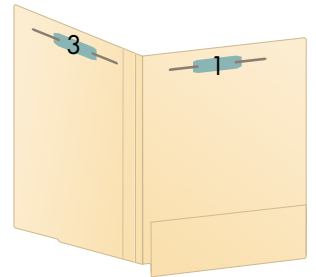

ITEM NO.	DESCRIPTION	LBS./BOX	QUANTITY
LI-FLD11-1P	11 pt., 1 fastener	50 lbs.	box of 500
LI-FLD15-2P	15 pt., 2 fastener	38 lbs.	box of 250

## Non-Reinforced Standard Folders

Durable, yet inexpensive non-reinforced folders are available without fasteners or with 2" bonded fasteners in positions #1 and #3.

- Size: 9-1/2" x 12-1/4".
- Made of sturdy 11 point manila stock.
- Side and top tabs

ITEM NO.	DESCRIPTION	LBS./BOX	QUANTITY
PMFLD-0	without fasteners	45 lbs.	box of 250
PMFLD	with fasteners	49 lbs.	box of 250

To Order Custom Imprint Call 1.888.822.9777.

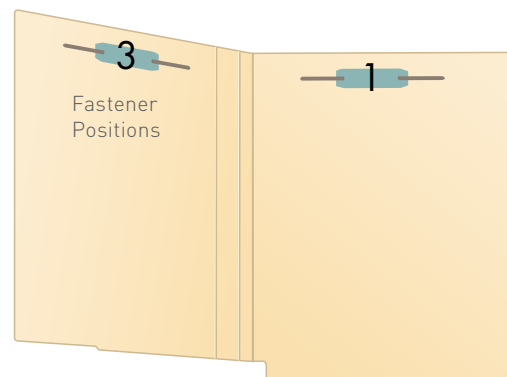



# Manila Folders

## AMES DuraTab Reinforced Expansion Folders

AMES 15 point manila expansion folders come with DuraTab interlocking double reinforced top and side tabs that stand up to frequent use.

- Side tab folders are designed for open shelf filing and feature outline blocks on the tabs for optional color-coded tapes.
- 2" tear-resistant Tyvek® gusset allows for durable expansion.
- Folders are scored above the fold for self expansion.

ITEM NO.	DESCRIPTION	SIZE	LBS./BOX	QUANTITY
OCFVX	15 pt., side tab, 2" gusset	9-1/2" x 12-1/8"	47.5 lbs.	box of 250

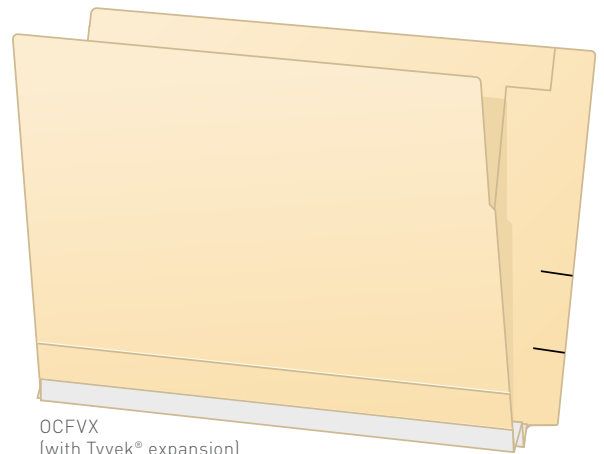

## AMES Standard Color-Coded File Folders

AMES DuraTab double-reinforced manila folders are labeled with 2 numeric color bars using the AMES Ten-Color System.

- Straight numerical collation.
- Standard size: 9-1/2" x 12-1/8".
- Choose 11 point or 15 point manila stock.
- 2CFV comes with 5 each of 00 to 99 per box; 2CFV15 comes with 2 each of 00 to 99 per box. Both collated in straight numeric order.
- DuraTab interlocking double-reinforced right side tab and top.
- Double-scored 1/2" and 1-3/8" above fold for expansion.

ITEM NO.	DESCRIPTION	LBS./BOX	QUANTITY
2CFV	11 pt. folder	46 lbs.	box of 500
2CFV15	15 pt. folder	32 lbs.	box of 200

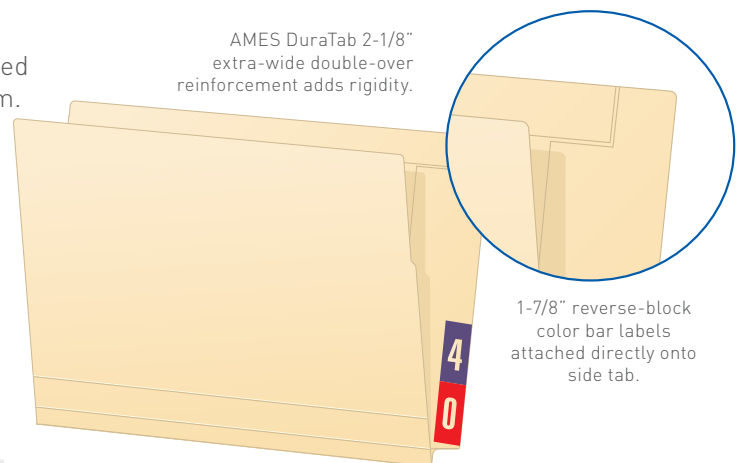

To Order Custom Imprint Call 1.888.822.9777.



ITEM NO.	DESCRIPTION	LBS./BOX	QUANTITY
2CFV-ST	2 color bar labels, 11 pt.	46 lbs.	box of 500
2CFV15-ST	2 color bar labels, 15 pt.	25.6 lbs.	box of 200
OCFV-ST	No color bar labels, 11 pt.	46 lbs.	box of 500
OCFV15-ST	No color bar labels, 15 pt.	32 lbs.	box of 250

## AMES Stock Copy File Folders With or Without Color Bar Labels

AMES DuraTab double-reinforced folders with stock copy that includes name line and year barometer.

- Size: 9-1/2" x 12-1/8".
- Choose 11 point or 15 point manila stock with same construction as folders above.
- Folders with terminal digit color coded numbering are collated in straight numeric order.
- 2CFV-ST is packed 5 each of 00 to 99 per box; 2CFV15-ST is packed 2 each of 00 to 99 per box.

To Order Custom Imprint Call 1.888.822.9777.





# Color Stripe Folders

## Add Color to Your World With Standard Side Tab and 2TAB, Solid Color Folders

Separate yourself from the crowd by using color to identify your files.

### Manila Color Stripe Folders



#### Letter

MODEL NO.	DESCRIPTION	QUANTITY
1162-**	11 pt. Standard	box of 100

#### Legal

MODEL NO.	DESCRIPTION	QUANTITY
1163-**	11 pt. Standard	box of 100

\*\*Choose appropriate color suffix.

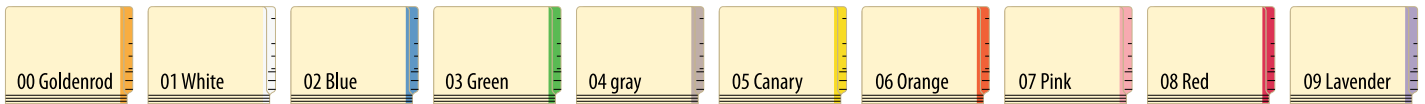

### White Folders with Color Side Tabs

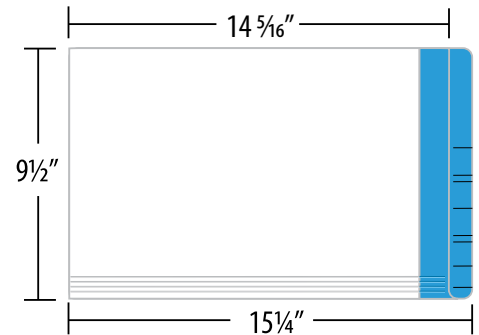
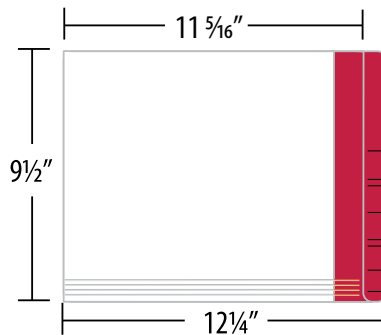

#### Letter

MODEL NO.	DESCRIPTION	QUANTITY
CN1219-*	14pt Eternafilm reinforced	box of 225
CN1259-*	14pt Eternafilm reinforced Long letter: 9 1/2 x 12 1/2 x 13 overall	box of 225

#### Legal

MODEL NO.	DESCRIPTION	QUANTITY
CN1229-*	14pt Eternafilm reinforced	box of 225

\*\*Choose appropriate color suffix.



# Solid Color Folders

## Standard Solid Color Side Tab Folders



### Letter

MODEL NO.	DESCRIPTION	QUANTITY
1106-**	11 pt. Standard	box of 100
1406-**	14 pt. Standard	box of 50



### Legal

MODEL NO.	DESCRIPTION	QUANTITY
1126-**	11 pt. Standard	box of 100
1426-**	14 pt. Standard	box of 50

\*\*Choose appropriate color suffix.

## 2TAB Solid Color Folders



### Letter

MODEL NO.	DESCRIPTION	QUANTITY
1334-**	11 pt. 2TAB	box of 100
1335-**	14 pt. 2TAB	box of 100

\*\*Choose appropriate color suffix.

11 pt. is double-ply top and side tabs. 14 pt. is single-ply top tab and double-ply side tab.



### Legal

MODEL NO.	DESCRIPTION	QUANTITY
1336-**	11 pt. 2TAB	box of 50
1337-**	14 pt. 2TAB	box of 50

# Solid Color Folders

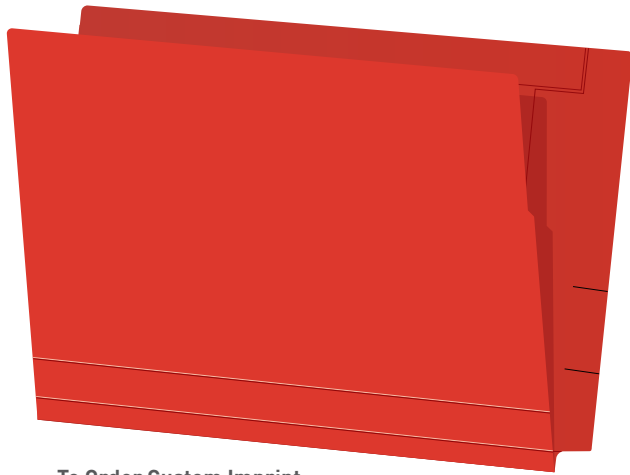

To Order Custom Imprint  
Call 1.888.822.9777.

## AMES Varicolor Folders

AMES Varicolor Folders feature right-side tab design and a choice of 11 point with 1/2" drop front or 15 point with flush cut front cover.

- DuraTab interlocking double-reinforced side tab for longer life.
- Standard size: 9-1/2" x 12-1/8".
- Scored 1/2" and 1-3/8" above fold for self expansion.
- 15 point folders feature flush cut, full-height fronts.
- 11 point folders feature 1/2" drop front design for drawer or open shelf filing.

ITEM NO.	DESCRIPTION	LBS./BOX	QUANTITY
See chart	11 pt., drop front	50 lbs.	box of 500
See chart	15 pt., flush cut	40 lbs.	box of 250

COLOR	Blue	Brown	Green	Grey	Orange	Pink	Purple	Red	Tan	White	Yellow
11 pt.	F-BL	F-BR	F-GR	F-GY	F-OR	F-PI	F-PU	F-RE	F-TA	F-WH	F-YE
15 pt.	F15-BL	F15-BR	F15-GR	F15-GY	F15-OR	F15-PI	F15-PU	F15-RE	F15-TA	F15-WH	F15-YE

## Top Tab Solid Color Folders



### Letter

MODEL NO.	DESCRIPTION	QUANTITY
1212-**	11 pt Double Ply Solid Color	box of 100
1222-**	14 pt Single Ply Solid Color	box of 100

Replace \*\* with a color number

### Legal

MODEL NO.	DESCRIPTION	QUANTITY
1211-**	11 pt Double Ply Solid Color	box of 100
1214-**	14 pt Single Ply Solid Color	box of 50

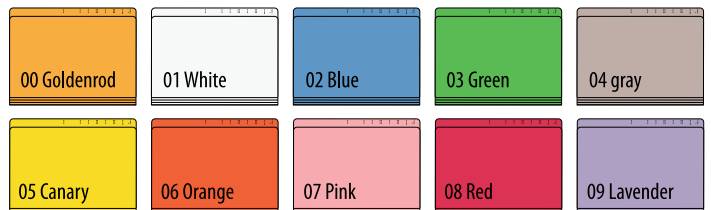

# Pressboard Expansion Folders



**25 pt. Type II  
Green/Gray Pressboard  
Standard**

## Letter

MODEL NO.	DESCRIPTION	QUANTITY
1235-00	1" Expansion Standard	box of 25
1236-00	2" Expansion Standard	box of 25



## Legal

MODEL NO.	DESCRIPTION	QUANTITY
1250-00	1" Expansion Standard	box of 25
1251-00	2" Expansion Standard	box of 25



## Letter

MODEL NO.	DESCRIPTION	QUANTITY
1237-00B	1" Expansion w/fasteners 1&3	box of 25
1238-00B	2" Expansion w/fasteners 1&3	box of 25
1249-00B	2" Expansion w/fasteners 1	box of 25



## Legal

MODEL NO.	DESCRIPTION	QUANTITY
1252-00B	1" Expansion w/fasteners 1&3	box of 25
1253-00B	2" Expansion w/fasteners 1&3	box of 25

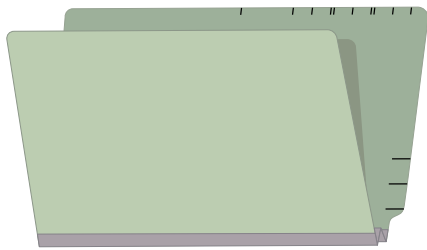

**25 pt. Type II  
Green/Gray Pressboard  
2TAB**

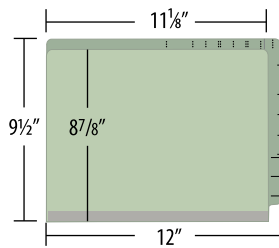

## Letter

MODEL NO.	DESCRIPTION	QUANTITY
1348-00	1" Expansion Standard	box of 25
1349-00	2" Expansion 2TAB	box of 25

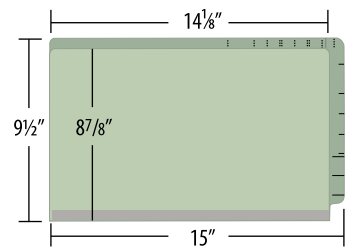

## Legal

MODEL NO.	DESCRIPTION	QUANTITY
1350-00	1" Expansion 2TAB	box of 25
1351-00	2" Expansion 2TAB	box of 25

**25 pt. Type II  
Color Pressboard**

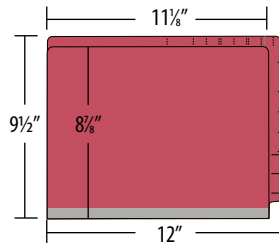
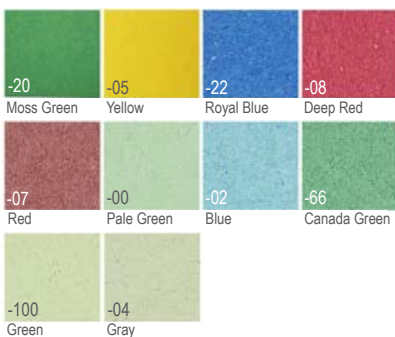

## Letter

MODEL NO.	DESCRIPTION	QUANTITY
1235-**	1" Expansion Standard	box of 25
1236-**	2" Expansion Standard	box of 25
1348-**	1" Expansion 2TAB	box of 25
1349-**	2" Expansion 2TAB	box of 25

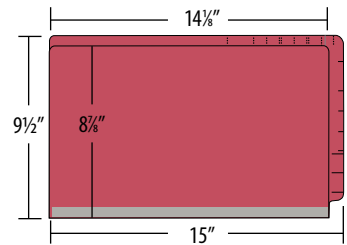

## Legal

MODEL NO.	DESCRIPTION	QUANTITY
1250-**	1" Expansion Standard	box of 25
1251-**	2" Expansion Standard	box of 25
1350-**	1" Expansion 2TAB	box of 25
1351-**	2" Expansion 2TAB	box of 25

All color pressboard folders may require up to a 35-day lead time.

\*\*Choose appropriate color suffix:

# Pressboard Classification Folders

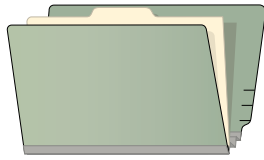

## 25 pt. Type II – Standard Green/Gray Pressboard

All folders with 1 & 2 dividers have 2" expansion.

All folders with 3 dividers have 3" expansion.

Fasteners included on folder and dividers.

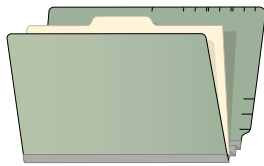

## 25 pt. Type II – 2TAB Green/Gray Pressboard

All folders with 1 & 2 dividers have 2" expansion.

Fasteners included on folder and dividers.

## 25 pt. Type II Color Pressboard

All folders with 1 & 2 dividers have 2" expansion.

All folders with 3 dividers have 3" expansion.

Fasteners included on folder and dividers.

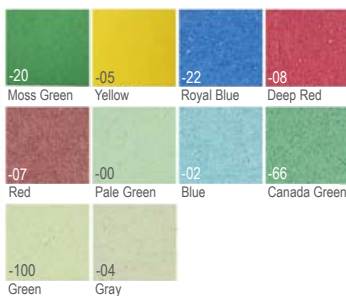

### Letter

MODEL NO.	DESCRIPTION	QUANTITY
1244-00B	Standard w/1 divider	box of 25
1245-00B	Standard w/2 dividers	box of 25
1243-00B	Standard w/3 dividers	box of 25

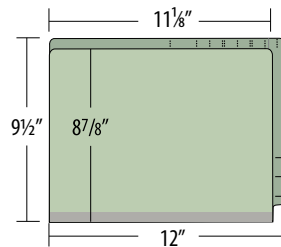

### Letter

MODEL NO.	DESCRIPTION	QUANTITY
1352-00B	2TAB w/1 divider	box 25
1353-00B	2TAB w/2 dividers	box 25



### Legal

MODEL NO.	DESCRIPTION	QUANTITY
1246-00B	Standard w/1 divider	box of 25
1247-00B	Standard w/2 dividers	box of 25
1248-00B	Standard w/3 dividers	box of 25

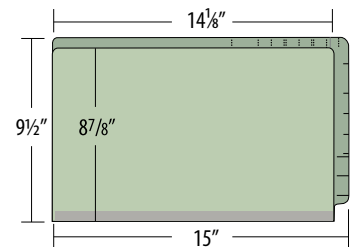

### Legal

MODEL NO.	DESCRIPTION	QUANTITY
1354-00B	2TAB w/1 divider	box 25
1355-00B	2TAB w/2 dividers	box 25



### Letter

MODEL NO.	DESCRIPTION	QUANTITY
1244-**B	Standard w/1 divider	box of 25
1245-**B	Standard w/2 dividers	box of 25
1243-**B	Standard w/3 dividers	box of 25
1352-**B	2TAB w/1 divider	box of 25
1353-**B	2TAB w/2 dividers	box of 25



### Legal

MODEL NO.	DESCRIPTION	QUANTITY
1246-**B	Standard w/1 divider	box of 25
1247-**B	Standard w/2 dividers	box of 25
1248-**B	Standard w/3 dividers	box of 25
1354-**B	2TAB w/1 divider	box of 25
1355-**B	2TAB w/2 dividers	box of 25

All color pressboard folders may require up to a 35-day lead time.

\*\*Choose appropriate color suffix:

## Alternatives to Pressboard

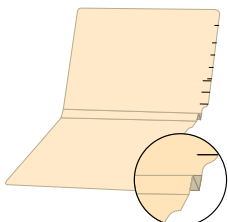

### 1 1/2" "W" Expansion

These sturdy 18 pt. manila folders have a paper W-fold on the bottom that expands to hold up to 1 1/2" of documents.

MODEL NO.	DESCRIPTION	QUANTITY
1196-00	Letter [9 1/2" h" x 11 3/4" w x 12 1/4" w overall]	box of 50
1197-00	Legal [9 1/2" h" x 14 3/4" w x 15 1/4" w overall]	box of 50



### Classification Folder – 1 & 2 Dividers

Allows documents to be subdivided within the folder into as many as six categories. These sturdy 18 pt. manila folders expand up to 1-1/2" and have 2" bonded fasteners in positions 1 and 3 of the folder. Each divider has twin prong fastener included.

MODEL NO.	DESCRIPTION	QUANTITY
1258-00B	Letter 9 1/2" x 11 3/4" - 12 1/4" - 1 divider	box of 25
1268-00B	Letter 9 1/2" x 11 3/4" - 12 1/4" - 2 dividers	box of 25
1259-00B	Legal 9 1/2" x 14 3/4" - 15 1/4" - 1 divider	box of 25
1269-00B	Legal 9 1/2" x 14 3/4" - 15 1/4" - 2 dividers	box of 25

# Pressboard Folders

## AMES Tyvek® Expansion Pressboard Folders

- Made of durable 25 point Type II pressboard.
- 2" tear-resistant Tyvek® gusset allows for durable expansion.
- Color: Green Grey.

Choose from two folder styles:

### OPRS-DF:

- 1/2" drop front folder.
- Designed for in-drawer files.

### OPRS-ST & OPRS-STEZ:

- 1/2" drop front with side tab
- Designed for open-shelf filing.
- OPRS-STEZ comes with Easclip in position 5.



MODEL NO.	DESCRIPTION	SIZE	LBS./BOX	QUANTITY
OPRS-DF	Drop front	9-1/2" x 11-3/4"	40 lbs.	box of 100
OPRS-ST	Side tab, drop front	9-1/2" x 12-1/8"	40 lbs.	box of 100
OPRS-STEZ	Side tab, drop front, Easclip	9-1/2" x 12-1/8"	44 lbs.	box of 100

To Order Custom Imprint  
Call 1.888.822.9777.

Tyvek is a registered trademark of DuPont.

## Type II Top Tab Pressboard and Classification Folders

All folders with 1 & 2 dividers have 2" expansion. Fasteners included on classification folders, in positions 1 & 3, and on dividers.

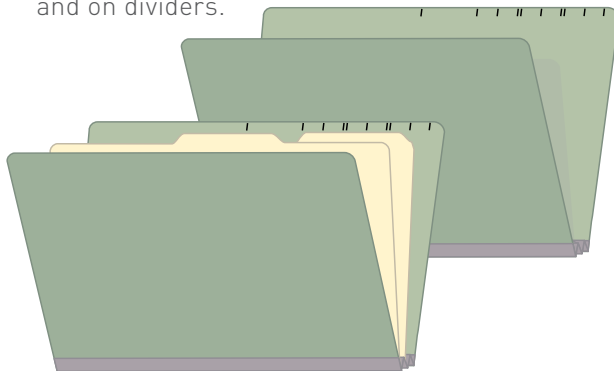

All color pressboard folders may require up to a 35-day lead time.

**Letter** (87/8" high front; 9 1/2" high back x 11 3/8" wide)

MODEL NO.	DESCRIPTION	QUANTITY
1255-00	25 pt Green/Grey 2" Expansion	box of 25
1255-**	25 pt Color 2" Expansion	box of 25

**Letter** (87/8" high front; 9 1/2" high back x 11 3/8" wide)

MODEL NO.	DESCRIPTION	QUANTITY
1254-00B	25 pt Green/Grey 1 Divider	box of 25
1254-**B	25 pt Color 1 Divider	box of 25
1454-00B	25 pt Green/Grey 2 Dividers	box of 25
1454-**B	25 pt Color 2 Dividers	box of 25

**Legal** (87/8" high front; 9 1/2" high back x 14 3/8" wide)

MODEL NO.	DESCRIPTION	QUANTITY
1257-00	25 pt Green/Grey 2" Expansion	box of 25
1257-**	25 pt Color 2" Expansion	box of 25

**Legal** (87/8" high front; 9 1/2" high back x 14 3/8" wide)

MODEL NO.	DESCRIPTION	QUANTITY
1256-00B	25 pt Green/Grey 1 Divider	box of 25
1256-**B	25 pt Color 1 Divider	box of 25
1456-00B	25 pt Green/Grey 2 Dividers	box of 25
1456-**B	25 pt Color 2 Dividers	box of 25

Replace \*\* with a color number

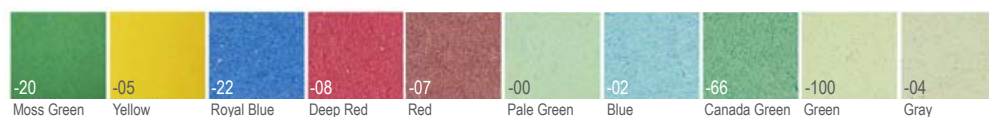



# Custom Options - Fasteners

## Fasteners

Need to permanently attach documents to your folder? Use these fasteners to convert your plain manila folder to a fastener folder quickly and permanently! From a simple self adhesive fastener, to a twin prong, or use a Docuclip fastener. Docuclips permit you to save time allowing you to interfile without removing pages.

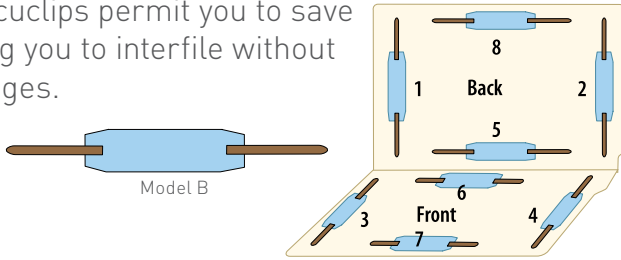

### FACTORY INSTALLED

MODEL NO.	DESCRIPTION	QUANTITY
B	2" Bonded Fastener	\$ 0.33/each

### SELF INSTALLED

MODEL NO.	DESCRIPTION	QUANTITY
1108-00	2" Self Adhesive	box of 100
1108-01	1" Twin Prong	box of 100
1108-02	2" Twin Prong	box of 100
1149-00	2" Foamclip	box of 100

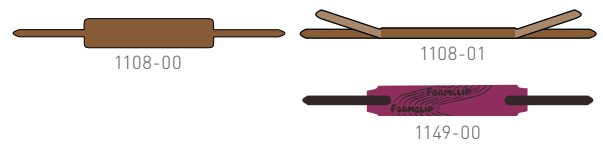

MODEL NO.	DESCRIPTION	LBS./BOX	QUANTITY
FAS-PERM-1L	1" prong	8 lbs.	box of 500
FAS-PERM-2L	2" prong	8 lbs.	box of 500

## AMES Bonded Fasteners

Enamel coated steel construction secured by tear-resistant non-woven fabric on an easy-to-install pressure-sensitive white tag base.

- Base size: 1-1/2" x 8-1/2".
- Choose from 1" (1L) or 2" (2L) prong capacities.

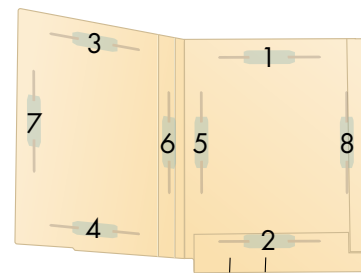

MODEL NO.	DESCRIPTION	LBS./BOX	QUANTITY
FAS-PRS-STK	2" prong	8 lbs.	box of 100

## AMES Presstik Fasteners

- Enamel-coated steel construction with pressure-sensitive adhesive.
- Available with 2" prongs only.

# Custom Options - Fasteners

## 2-Prong DocuClip

This unique plastic fastener is an alternative to three-ring binders for active or inactive records. An ideal alternative when converting documents from bulky binders into a pressboard expansion folder!

This fastener has a self-adhesive back allowing for easy insertion into any file folder. It's flexible, three piece design features legs that are easily removed so documents can be inserted, removed or copied without disturbing preceding pages.

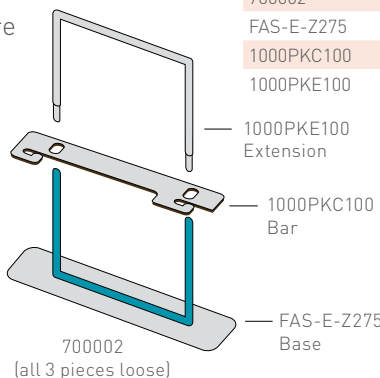
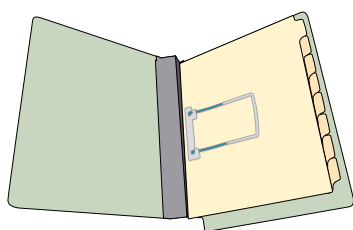

### FACTORY INSTALLED

MODEL NO.	DESCRIPTION	QUANTITY
E=70001	2-Prong Docuclip	box of 100

### SELF INSTALLED

MODEL NO.	DESCRIPTION	QUANTITY
700002	2-Prong Docuclip - complete - 3 pieces	box of 100
FAS-E-Z275	2-Prong Docu Base Compressor	box of 100
1000PKC100	2-Prong Docu Bar	box of 100
1000PKE100	2-Prong Docu Extension	box of 100

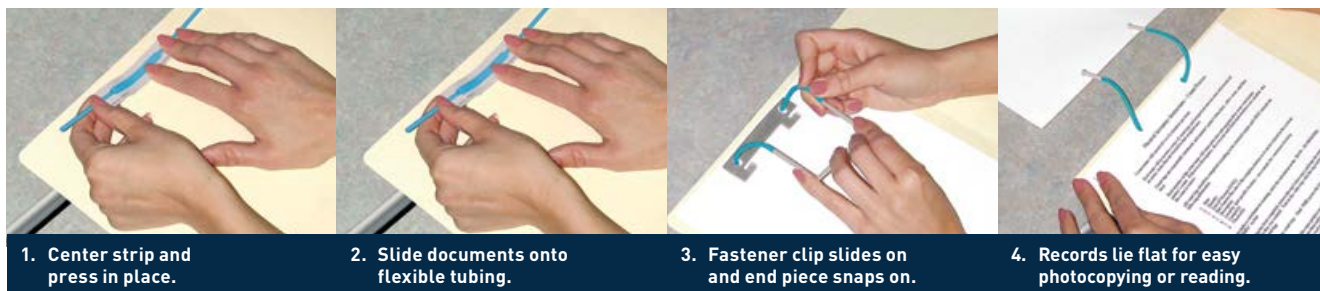

## AMES Attach-Yourself Easiclip Fasteners

Attach Easiclips to folders, filebacks, report covers – anywhere you need to secure documents.

- Available in standard (3-3/4") or large size (8-1/2") base.
- Sets contain all three component pieces (see right):
  - A. Extension piece.
  - B. Compressor bar.
  - C. Tubing and base with pressure sensitive self adhesive.
- Components also available separately as "Spare Parts".

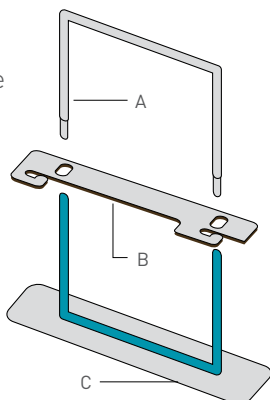

### Easiclip Sets

MODEL NO.	DESCRIPTION	LBS./BOX	QUANTITY
EZ275RBIC	Standard base set, 100-pack	3 lbs.	box of 100
EZ275RBIM	Standard base set, economy pack	27 lbs.	box of 1000

### Easiclip Spare Parts

MODEL NO.	DESCRIPTION	LBS./BOX	QUANTITY
EZ-EXT-275	Extension pieces	2 lbs.	box of 250
EZ-CMP-275	Compressor bars	2 lbs.	box of 250
FAS-E-Z275A	Standard bases with tubing	8 lbs.	box of 1000

# Custom Options - Pockets

## Clear Vinyl Pockets

Small documents can be organized and secured within a file using pockets. Made from vinyl each has a self adhesive back to firmly attach the pocket to the folder.

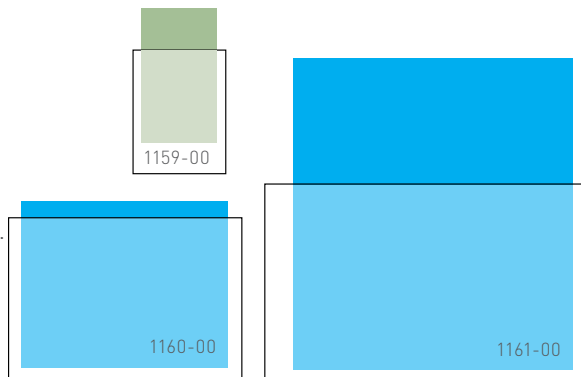

### SELF INSTALLED

MODEL NO.	DESCRIPTION	WEIGHT	QUANTITY
1159-00	Vinyl 2 1/4" w x 3 1/8" h	5 lbs.	box of 100
1160-00	Vinyl 6" w x 4" h	13 lbs.	box of 100
1161-00	Vinyl 8 3/4" w x 5" h	21 lbs.	box of 100

All dimensions are inside dimensions.

## Manila Pockets

Want to keep small items from falling out of your file? Add a manila pocket in one or several locations. From credit cards to letter size documents these factory installed pockets can improve your information process.

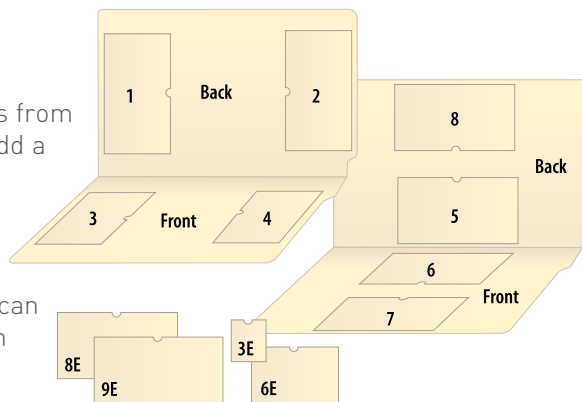

### FACTORY INSTALLED

MODEL NO.	DESCRIPTION	QUANTITY
F	3E Manila 2 1/2" w x 3 1/8" h	box of 100
G	6E Manila 6 1/4" w x 4 1/8" h	box of 100
H	8E Manila 8 5/8" w x 4 3/4" h	box of 100
J	9E Manila 9 3/8" w x 4 3/4" h	box of 100
K	Vinyl 2 1/4" w x 3 1/8" h (1159-00)	box of 100
L	Vinyl 6" w x 4" h (1160-00)	box of 100
M	Vinyl 8 1/2" w x 5" h (1161-00)	box of 100

## AMES Polyethylene Pocket Attachments

- Made of clear, non-yellowing, heavy-duty 5-gauge polyethylene with pressure-sensitive adhesive backing.



MODEL NO.	DESCRIPTION	INTERIOR DIMENSIONS	LBS./BOX	QUANTITY
13-411L	Open side	6-1/2" x 4-1/4"	15 lbs.	box of 1000

\*Opens on long edge.



# Custom Options

## Printing

Outside Front, Inside Front, Inside Back, Outside Back. 500 or 100,000. One Color. Two colors. Your artwork. Our artwork. TAB can print whatever you want wherever you want it.

FACTORY INSTALLED		
MODEL NO.	DESCRIPTION	QUANTITY
P	Printing One Color One Panel	box of 100
Q	Printing Numbering on Folder	box of 100
R	Printing Two Colors One Panel	box of 100

500 piece minimum for printing.

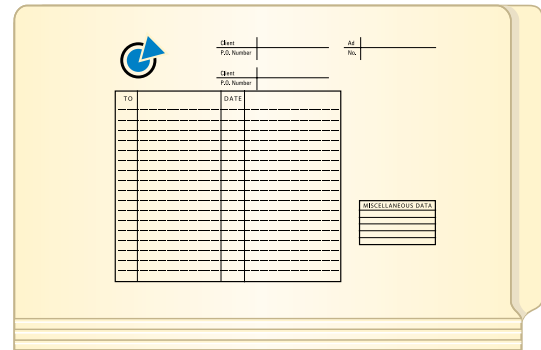

## Custom Dividers

Keep information in organized groups within your folder with installed dividers. Optional twin prong fastener allows for attaching documents on either side of the divider.

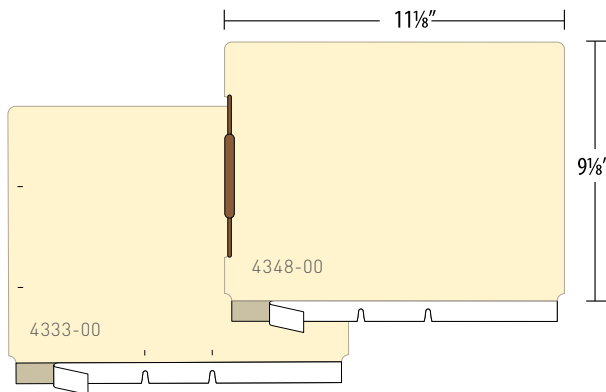
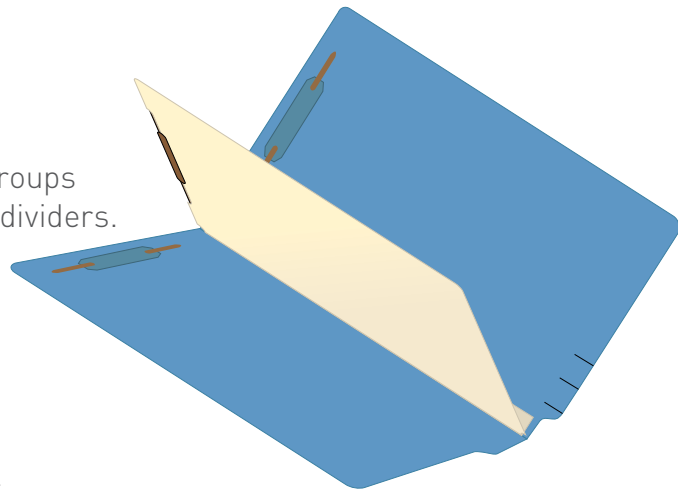

### Pressure-Sensitive Dividers

Made of 11 pt. Manila, convert files to multiple classifications.

#### Letter

FACTORY INSTALLED		
MODEL NO.	DESCRIPTION	QUANTITY
N=4333-00	9 1/8" h x 11 1/8" w	box of 100
O=4348-00	9 1/8" h x 11 1/8" w with 1" twin prong fastener	box of 100

#### SELF INSTALLED

MODEL NO.	DESCRIPTION	QUANTITY
4333-00	9 1/8" h x 11 1/8" w	box of 100
4348-00	9 1/8" h x 11 1/8" w with 1" twin prong fastener	box of 100

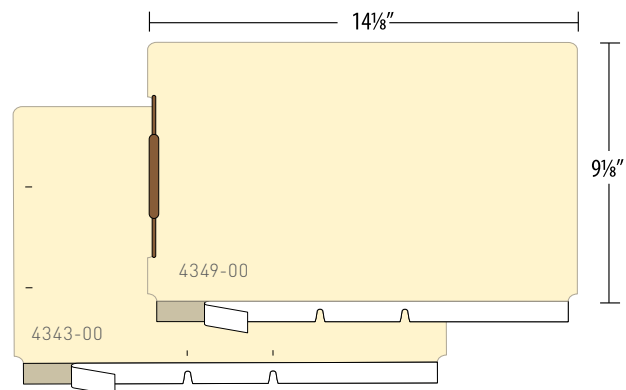

#### Legal

FACTORY INSTALLED  
CALL FOR QUOTE.

#### SELF INSTALLED

MODEL NO.	DESCRIPTION	QUANTITY
4343-00	9 1/8" h x 14 1/8" w	box of 100
4345-00	11 1/2" h x 15 3/8" w	box of 200
4349-00	9 1/8" h x 14 1/8" w with 1" twin prong fastener	box of 100

## Keep Documents Safe

With closed sides these pockets keep small items in file with larger documents. Available with two sides closed, three sides closed, manila or color side tab.



### Manila Pockets – Closed 2 Sides

#### Letter

MODEL NO.	DESCRIPTION	QUANTITY
1178-00	11 pt Manila Flat Pocket	box of 100
1175-00	11 pt Manila Pocket 1 1/2" expansion	box of 50

#### Legal

MODEL NO.	DESCRIPTION	QUANTITY
1179-00	11 pt Manila Flat Pocket	box of 50
1176-00	11 pt Manila Pocket 1 1/2" expansion	box of 50

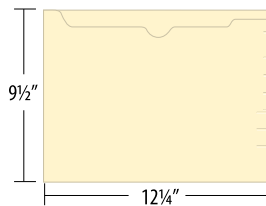
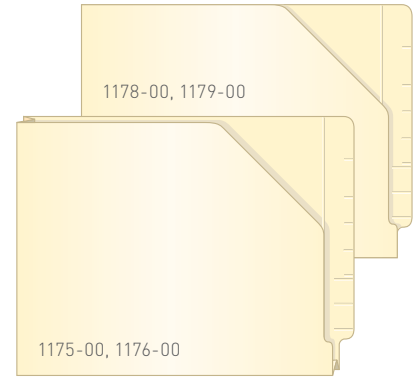

### Manila Pockets – Closed 3 Sides

#### Letter

MODEL NO.	DESCRIPTION	QUANTITY
1168-00	11 pt Manila Flat Pocket	box of 100
1180-00	11 pt Manila Pocket 3/4" expansion	box of 100

#### Legal

MODEL NO.	DESCRIPTION	QUANTITY
1169-00	11 pt Manila Flat Pocket	box of 100
1181-00	11 pt Manila Pocket 3/4" expansion	box of 50

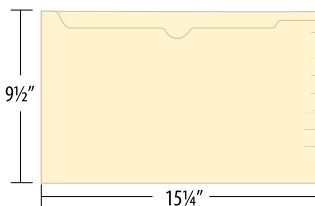
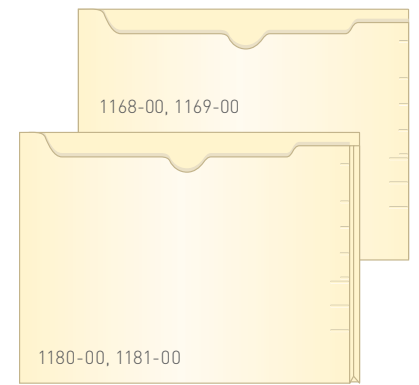

### Manila Color Stripe Flat Pockets – Closed 2 Sides

#### Letter

MODEL NO.	DESCRIPTION	QUANTITY
1172-**	11 pt Color Stripe Flat Pocket	box of 100

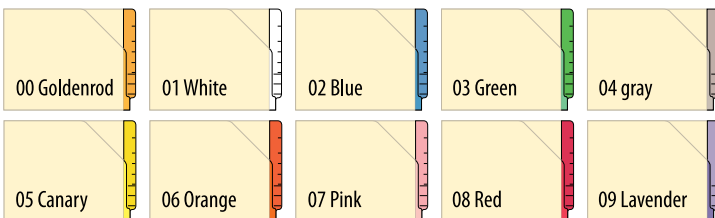

\*\*Choose appropriate color suffix:

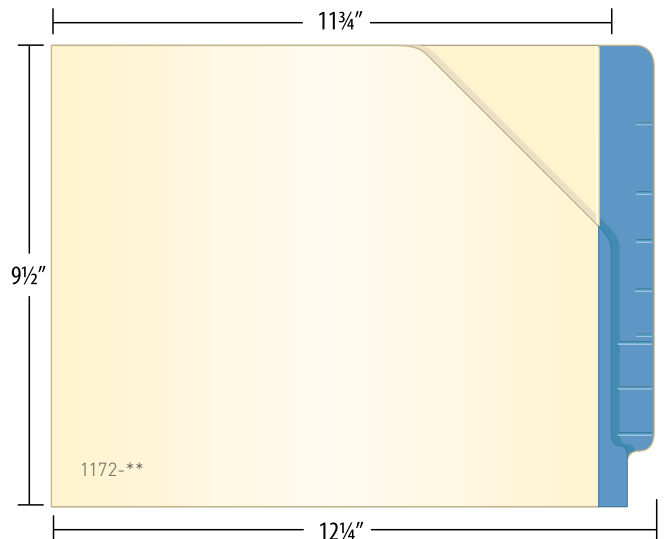

# Pockets

## Color One-Piece Pockets

### Letter

MODEL NO.	DESCRIPTION	QUANTITY
1174-**-	11 pt Color One Piece Flat Pocket closed two sides	box of 100
1184-**-	11 pt Color One Piece Pocket w/ 4" Lower End Tab	box of 100
1166-**-	11 pt Color Flat Pocket closed 3 sides	box of 100

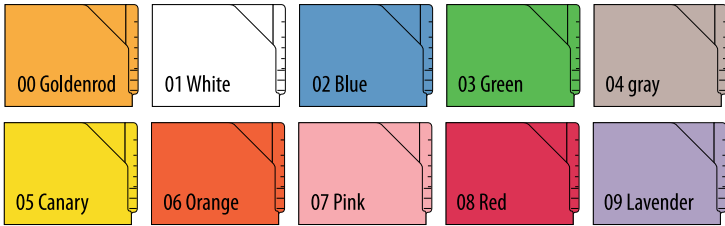

\*\*Choose appropriate color suffix.



## AMES Color Slash-Cut Pockets

Organize by color while keeping a portion of your contents visible for quick identification with AMES Slash-Cut Pockets. Ideal for holding information that you do not want to staple or clip together.

- Open end design helps secure contents in pocket.
- Made of durable 11 point stock with glued 1" side seams.
- Size: 9-3/4" x 11-1/2".

MODEL NO.	LBS./BOX	QUANTITY
See below	14 lbs.	box of 200

Blue	Canary	Green	Pink	Purple	Scarlet	Tan
SLH-BL	SLH-CA	SLH-GR	SLH-PI	SLH-PU	SLH-SC	SLH-TA

## AMES Dental Patient Pocket Folders

AMES Dental Patient Folders feature an oversized built-in pocket with thumbcut opening at the center.

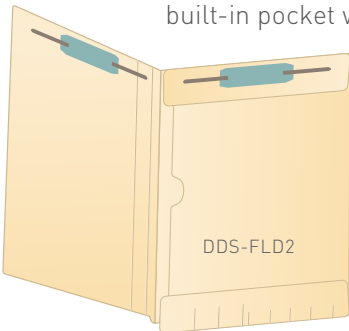

- Pocket size: 12-1/4" high x 9-3/8" wide.
- Front size: 11-1/2" high x 9-1/2" wide.
- Made from 11 point manila stock.
- Scored for self expansion.
- Available with 2" bonded fasteners. (See positioning at left.)

MODEL NO.	DESCRIPTION	LBS./BOX	QUANTITY
DDS-FLD2	2 fasteners, p1 & 3	39 lbs.	box of 250

To Order Custom Imprint Call 1.888.822.9777.



## Full Pocket File Folder

### Letter

MODEL NO.	DESCRIPTION	QUANTITY
1139-00	11 pt Manila letter size, full single ply side tab, closed 3 sides	box of 50



# Pockets



## 22 pt. Red Rope Expansion Pockets with Color Backs

### Letter

MODEL NO.	DESCRIPTION	QUANTITY
1187-**	1 3/4" Standard Color Back Expansion Pockets	box of 50
1189-**	3 1/2" Standard Color Back Expansion Pockets	box of 50
4387-**	5 1/4" Standard Color Back Expansion Pocket	box of 50

### Legal

MODEL NO.	DESCRIPTION	QUANTITY
1191-**	1 3/4" Standard Color Back Expansion Pocket	box of 50
1193-**	3 1/2" Standard Color Back Expansion Pockets	box of 50
4397-**	5 1/4" Standard Color Back Expansion Pocket	box of 50

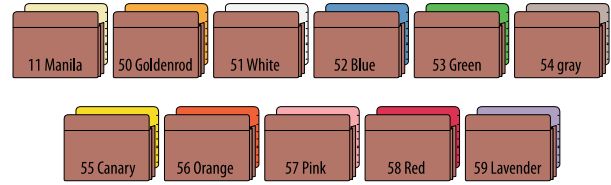

\*\*Choose appropriate color suffix.

Red rope front and gusset, color back, gusset height 6 1/2"

## 22 pt. Standard Solid Color Expansion Pockets

### Letter

MODEL NO.	DESCRIPTION	QUANTITY
1379-**	3 1/2" Standard Solid Color Expansion Pockets	box of 50

### Legal

MODEL NO.	DESCRIPTION	QUANTITY
1381-**	3 1/2" Standard Solid Color Expansion Pockets	box of 50



1381-\*\*



\*\*Choose appropriate color suffix.

## Low Gusset Expansion Pockets

### 22 pt. Red Rope Front and Bright Goldenrod Back

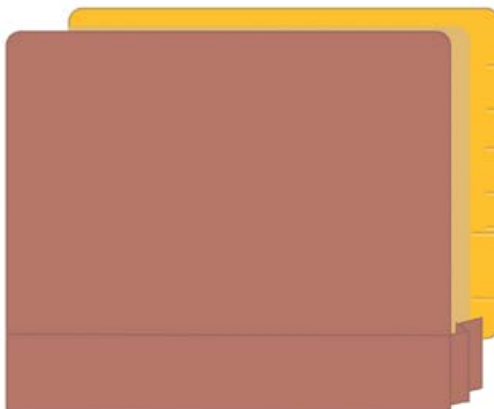

1187-00

Red rope front and gusset, goldenrod back, left gusset height 9", right gusset height 1 1/2"

### Letter

MODEL NO.	DESCRIPTION	QUANTITY
1187-00	1 3/4" Expansion [9 1/2" h, 11 3/4" w x 12 1/4" w overall]	box of 50
1189-00	3 1/2" Expansion [9 1/2" h, 11 3/4" w x 12 1/4" w overall]	box of 50

### Legal

MODEL NO.	DESCRIPTION	QUANTITY
1191-00	1 3/4" Expansion [9 1/2" h, 14 3/4" w x 15 1/4" w overall]	box of 50
1193-00	3 1/2" Expansion [9 1/2" h, 14 3/4" w x 15 1/4" w overall]	box of 50

# Pockets

## Manila Expansion Pockets

Jeter expansion pockets have many premium attributes, including:

- Superior Quality
- Maximum Gusset Strength
- Extra Deep Glued Edge Adds Durability
- Extra Strong Corners With Optional Rivets
- Longer Pocket Tabs for Better Label Fit
- Extra Heavy Covers, Front & Back

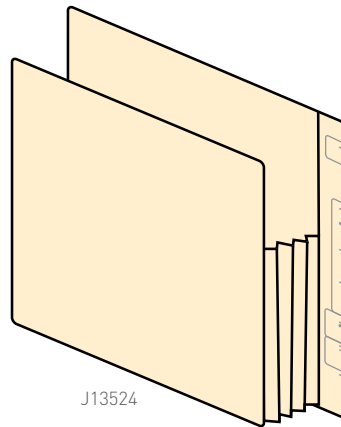

### Letter (12-3/8" wide x 9-1/2" high)

MODEL NO.	EXPANSION	DOUBLE PLY	PAPER POINT	QTY./ CARTON	WT./ CARTON
J13514	1-3/4"	•	14	50	11
J13524	3-1/2"	•	14	50	11
J13534	5-1/4"	•	14	50	16

### Legal (15-3/8" wide x 9-1/2" high)

MODEL NO.	EXPANSION	DOUBLE PLY	PAPER POINT	QTY./ CARTON	WT./ CARTON
J13516	1-3/4"	•	14	50	14
J13526	3-1/2"	•	14	50	16
J13536	5-1/4"	•	14	50	20

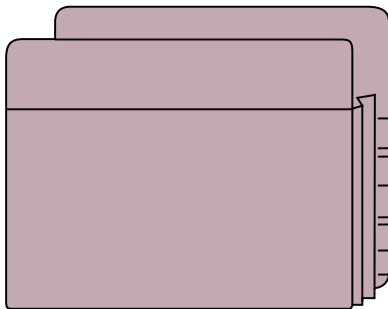

## 22 pt. Expansion Pockets

### Letter

MODEL NO.	DESCRIPTION	QUANTITY
F5600	1 3/4" Expansion Lavender	box of 50
F5650	3 1/2" Expansion Lavender	box of 50
F5610	5 1/4" Expansion Lavender	box of 50

### Legal

MODEL NO.	DESCRIPTION	QUANTITY
F5700	1 3/4" Expansion Lavender	box of 50
F5750	3 1/2" Expansion Lavender	box of 50
F5755	3 1/2" Expansion Red Rope	box of 50

## Expansion Pockets 42 pt. backs, 28 pt. Front

### Letter

MODEL NO.	DESCRIPTION	QUANTITY
F1832	1 3/4" Expansion Red Rope	box of 50
F1834	3 1/2" Expansion Red Rope	box of 50

### Legal

MODEL NO.	DESCRIPTION	QUANTITY
F1842	1 3/4" Expansion Red Rope	box of 50
F1844	3 1/2" Expansion Red Rope	box of 50

### Long Letter

MODEL NO.	DESCRIPTION	QUANTITY
F1852	1 3/4" Expansion Red Rope Long Letter 13" W	box of 50
F1854	3 1/2" Expansion Red Rope Long Letter 13" W	box of 50

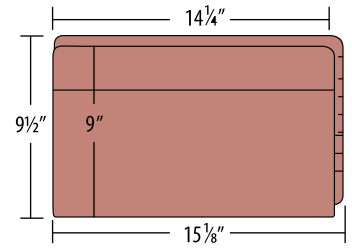
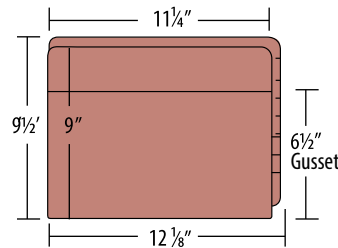

## Top Tab Expansion Pockets

### 22 pt. Red Rope, Gusset height 6 1/2"

**Letter** (9" high front; 9 1/2" high back x 11 3/4" wide)

MODEL NO.	DESCRIPTION	QUANTITY
1130-00	1 3/4" Expansion	box of 50
1131-00	3 1/2" Expansion	box of 50

**Legal** (9" high front; 9 1/2" high back x 14 3/4" wide)

MODEL NO.	DESCRIPTION	PRICE
1132-00	1 3/4" Expansion	box of 50
1133-00	3 1/2" Expansion	box of 50



# Health Care



1177-25

1177-00

## One Piece Manila X-Ray Jackets 14 1/2" x 18 1/4"

MODEL NO.	DESCRIPTION	QUANTITY
1177-00	11 pt. flat	box of 100
1177-25	11 pt. flat	box of 100

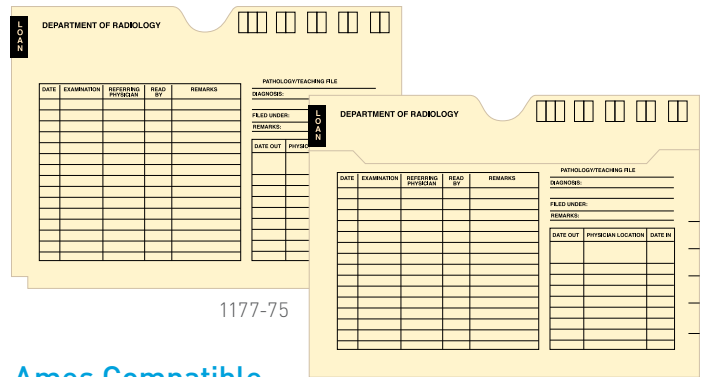

1177-75

1177-50

## Ames Compatible One Piece Manila X-Ray Jackets 14 1/2" x 18 1/4" x 3/4"

MODEL NO.	DESCRIPTION	QUANTITY
1177-75	11 pt. 3/4" expandable	box of 100
1177-50	11 pt. dual pocket	box of 100

## AMES Standard Copy Color-Coded X-Ray Jackets

AMES Standard Copy Color-Coded X-Ray Jackets feature terminal digit color coded numbering with year code.

- Size: 14-1/2" x 18-1/4", including 3/4" self expansion.
- Made of 11 point manila stock.
- Available with or without natural wallet border.
- Two printed AMES color bars on both sides.
- Stock copy includes printed outline blocks for taping codes and loan indicator bar.
- Indicator bar shows when jacket is turned around on shelf, indicating films are on loan.
- Scored for easy expansion.
- Offset double thumbcut for easy access to contents.
- Open-side design (opens along long edge).

MODEL NO.	DESCRIPTION	LBS./BOX	QUANTITY
OCXE-DST	Stock copy	21 lbs.	box of 100
OCXE-NST	Stock copy, natural wallet border	21 lbs.	box of 100
OCXE-DF-PL	Plain, no printing	21 lbs.	box of 100

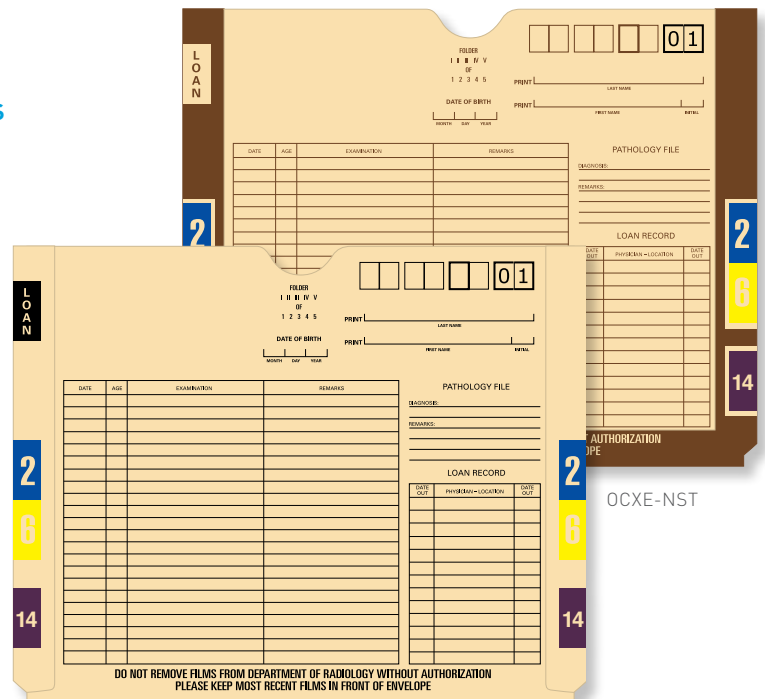

OCXE-NST

OCXE-DST

## AMES DuoPocket® X-Ray Jackets

DuoPocket's unique design eliminates tearing problems common with "slot-style" pocketed jackets.

- Size: 14-1/2" x 18-1/4", including 3/4" self expansion.
- Front report pocket size: 10" x 15-3/4" with 3/4" expansion.
- Made of 11 point manila stock.
- Available plain or with stock copy (shown right) that includes printed outline blocks for taping codes and loan indicator bar.
- Scored for easy expansion.
- Offset double thumbcut for easy access to contents.
- Open-side design (opens along long edge).
- Choose no color bars or terminal digit color coded numbering.
- Printed jackets available with natural wallet border.

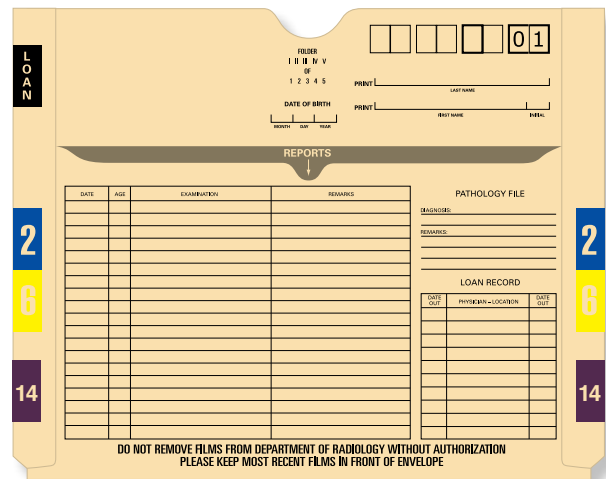

CXE-DF-ST-DPKT

MODEL NO.	DESCRIPTION	LBS./BOX	QUANTITY
OCXE-DUO-PL	Plain, no printing	26 lbs.	box of 100
OCXE-DST-DP	Printed	26 lbs.	box of 100
OCXE-NST-DP	Printed, natural wallet border	26 lbs.	box of 100
CXE-DF-ST-DPKT-**	Printed, 2 color bars	26 lbs.	box of 100

For CXE models add two-digit year code for appropriate year; for example: CXE-DF-ST-DPKT-21 for 2021

## AMES Midi Jackets

Choose plain, standard stock copy, "universal" midi jackets or standard stock copy with color bars. Midi jackets can be personalized with your logo or other imprinting.

- Size: 9-9/16" x 12-3/4", including 3/4" self expansion.
- Made of 11 point manila stock.
- Black indicator bar shows when jacket is turned around on shelf, indicating films are on loan.
- Offset double thumbcut for easy access to contents.
- Scored for easy expansion.
- Open-side design (opens along long edge).
- Terminal digit color coded numbering (5 each of 00 to 99 per box; collated in straight numeric order).
- Universal midi jackets include stock copy and check boxes for different exams. (See right.)

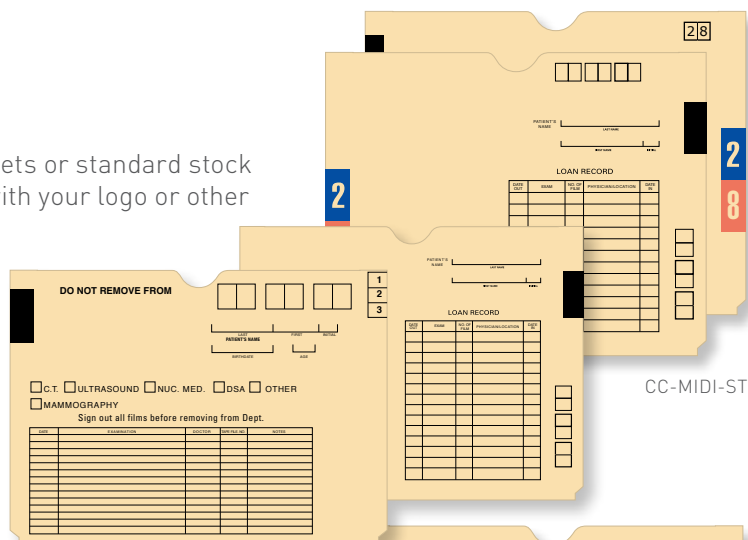

CC-MIDI-ST

MIDI-ST-UNIV

MODEL NO.	DESCRIPTION	LBS./BOX	QUANTITY
CC-MIDI-ST	2 color bars, stock copy	42 lbs.	box of 500
MIDI-ST-UNIV	Universal copy	21 lbs.	box of 250
MIDI-ST	Stock copy	21 lbs.	box of 250

To Order Custom Imprint Call 1.888.822.9777.

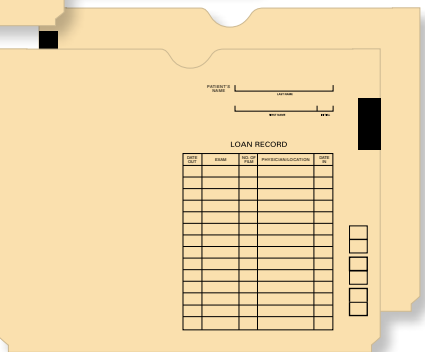

MIDI-ST



## AMES Green Diamond Border Mailers

- Made of 11 point manila stock.
- Green diamond border with "X-Ray Film" and "Please Do Not Bend" printed in red.
- Select from 2 sizes: 11" x 13" with 1-1/2" flap or 15" x 18" with 2" flap.
- Choose from 3 flap closure styles: String and button, Strip 'n' Stick, or plain flap.

	MODEL NO.	FLAP STYLE	LBS./BOX	QUANTITY
<b>11" x 13" MAILERS</b>	XM1113DSS	Strip 'n' Stick	14 lbs.	box of 100
	XM1113D	Plain Flap	14 lbs.	box of 100
<b>15" x 18" MAILERS</b>	XM1518DSS	Strip 'n' Stick	20 lbs.	box of 50
	XM1518D	Plain Flap	20 lbs.	box of 100

To Order Custom Imprint Call 1.888.822.9777.

Open side  
(long edge)



Open end  
(short edge)

## X-Ray Category Inserts

Locate specific examinations at a glance using solid-color and printed border stock color systems.

- Manufactured of 40 lb. kraft stock.
- Color coding by category permits quick location of films.
- Open-side category name printed on both sides of thumbcut, and open-end style features category name on top and bottom for easy identification.
- All inserts are available in open-end and open-side styles.
- Choose from 2 sizes: 14-1/4" x 17-1/2" and 10-1/2" x 12-1/2"
- Black copy, except where noted.

SIZE	MODEL NO.	LBS./BOX	QUANTITY
14-1/4" x 17-1/2"	See below	25 lbs.	box of 250
10-1/2" x 12-1/2"	See below	14 lbs.	box of 250

14-1/4" x 17-1/2"

10-1/2" x 12-1/2"

OPEN-END MODEL NO.	OPEN-SIDE MODEL NO.	OPEN-END MODEL NO.	OPEN-SIDE MODEL NO.	CATEGORY	STOCK COLOR	BORDER COLOR	COPY COLOR
-	CXIOS-AN	-	-	Angio	White	Purple	Black
CXIOE-BN	CXIOS-BN	-	-	Bone	White	Yellow	Black
CXIOE-CH	-	-	-	Chest	White	Brown	Black
ACXIOE-CT	-	-	-	CT	White	Red	Black
CXIOE-CT	-	-	-	CT	Khaki	-	Black
-	PC-OS-CT	-	-	CT	White	Dark Green	Black
-	CXIOS-HN	-	-	Head & Neck	White	Light Blue	Black
CXIOE-MAM	-	MCXIOE-MAM-250	MCXIOS-MAM-250	Mammography	White	Pink	Black
-	PC-OS-MAM	PC-OE-MMM-250	-	Mammography	White	Dark Blue	Black
ACXIOE-MRI	-	-	-	MRI	White	Teal	Black
-	PC-OS-MRI	-	-	MRI	White	Rust	Black
-	-	-	MCXIOS-NUC-250	Nuclear Medicine	Buff	-	Black
PC-OE-NUC	-	-	-	Nuclear Medicine	White	Red	Black
CXIOE-PR	-	-	-	Special Procedures	White	Olive	Black
CXIOE-MC	CXIOS-MC	-	-	Miscellaneous	White	-	Black
CXIOE-PL	CXIOS-PL	-	MCXIOS-PL-250	Blank (no copy)	White	-	None
CXIOE-NC	CXIOS-NC	-	-	Standard copy, no category	White	Dark Blue	Black

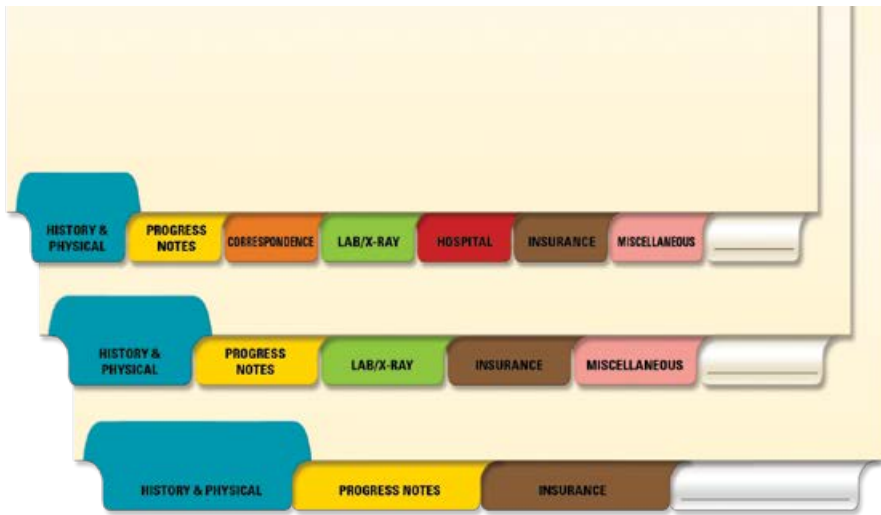

## INTRODUCING Three New Standard Health Care Title Sets

Available in styles A, B & C

90# manila stock; 1/2" tab extension; collated into sets. End tab is blank for easy-to-write titles.

MODEL NO.	TABS	STYLE
TI52008	8-Tabs	Style A
TI54008	8-Tabs	Style B
TI56008	8-Tabs	Style C
TI52006	6-Tabs	Style A
TI54006	6-Tabs	Style B
TI56006	6-Tabs	Style C
TI52004	4-Tabs	Style A
TI54004	4-Tabs	Style B
TI56004	4-Tabs	Style C

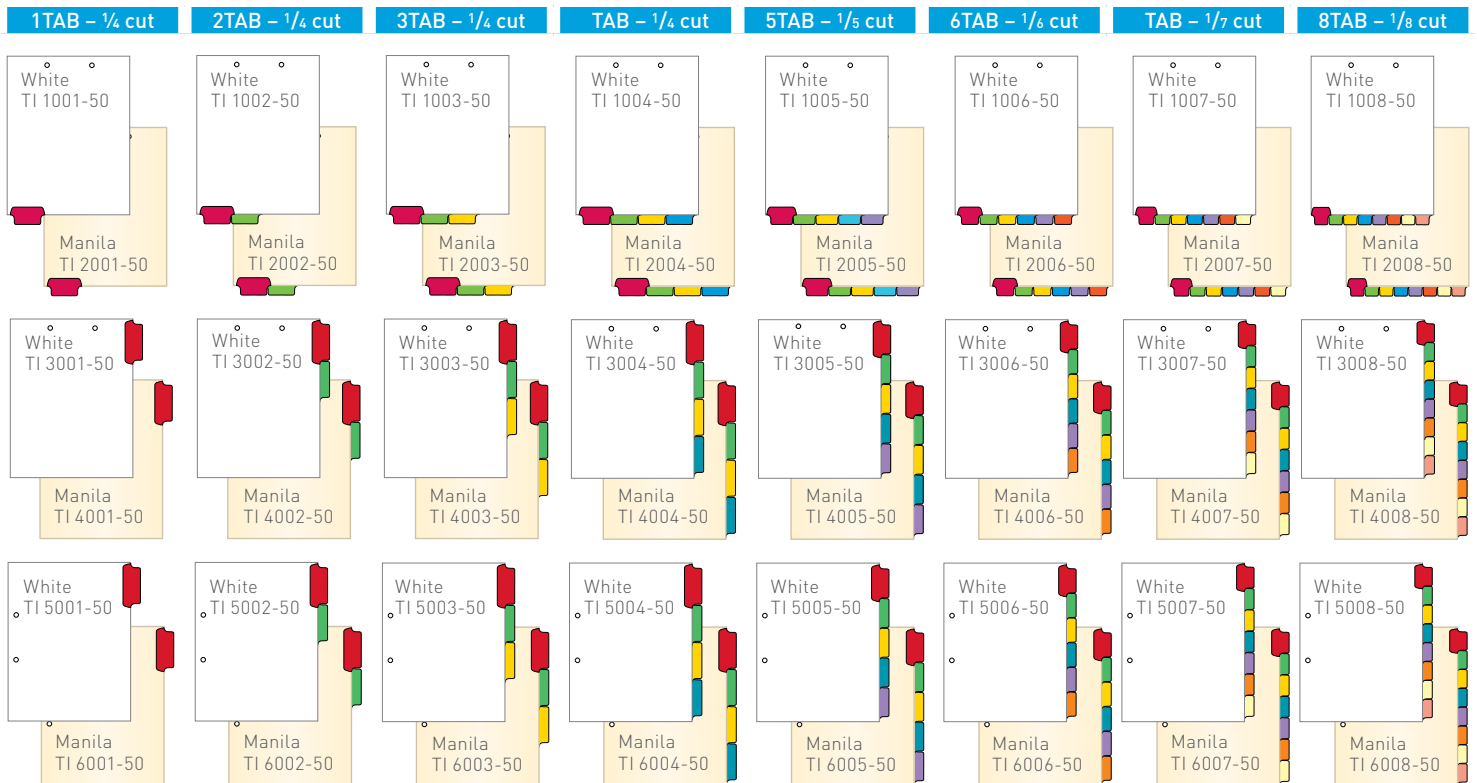

Minimum order quantity is a set of 50 indexes.



# Custom Indexes & Filebacks

## Indexes



**INDEX A**  
8 1/2" w x 11 1/2" h  
 90# White  
 90# Manila  
Fasteners N/A



**INDEX B**  
9" w x 11" h  
 90# White  
 90# Manila  
Fasteners N/A



**INDEX C**  
9" w x 11" h  
 90# White  
 90# Manila  
Fasteners N/A

## Bottom Tabs

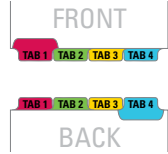

**Top Hinge A, D  
Print Style A**

- Same Print, both sides (standard)
- Print front only
- No print on Tabs

## Side Tabs



**Top Hinge B, E  
Print Style B**

- Same Print, both sides (standard)
- Print front only
- No print on Tabs



**Side Hinge C, F, Duotab  
Print Style C**

- Same Print, both sides (standard)
- Print front only
- No print on Tabs

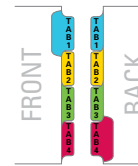

**Print Style D**

- Same Print, both sides (standard)
- Print front only
- No print on Tabs

## Tab Size

- 1/2" Standard Index
  - 3/8" Standard Fileback
  - 1/4" Special
- From top of page to top of tab

## Filebacks

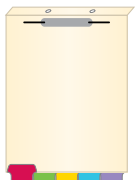

**FILEBACK D**  
8 1/2" w x 12 1/2" h  
1" hinge  
110# Manila  
 No Fasteners  
 2" Fastener

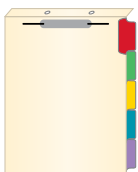

**FILEBACK E**  
9" w x 12" h  
1" hinge  
110# Manila  
 No Fasteners  
 2" Fastener

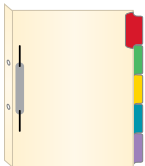

**FILEBACK F**  
10" w x 11" h  
1" hinge  
110# Manila  
 No Fasteners  
 2" Fastener

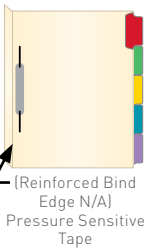

**FILEBACK DUOTAB**  
10" w x 11" h  
1" hinge  
110# Manila  
 No Fasteners  
 2" Fastener (front & back)

(Reinforced Bind Edge N/A)  
Pressure Sensitive Tape

Please indicate if you would like the fastener installed in another position than shown above.

## Quantity

No. of Tabs	No. of Sets	Total Tabs

**Cut**  Letter size  Legal size

**Collate** Tabs into Sets?

**Install** Tabs into Folders?

## Bind Edge Reinforcement

Yes (standard)  No Reinforcement

## Drilling

- Indexes: 2 holes (5/16")
- Filebacks: 2 slots (1/4")
- 2 3/4" centers, standard
- Special: \_\_\_\_\_

## Printing

Font: **Helvetica Bold** (standard)  
Style:  ALL CAPS  Initial Caps  
Body Print:  
 Body Print - PDF Provided  
 Dealer Reorder Information:  
\_\_\_\_\_

NOTE: If no selection is made, your order will be produced using the "Standard" choice unless a sample is provided, which we will match exactly.

## Tab Copy

Position	Text	Color/No.
<b>SAMPLE</b>	<b>Correspondence</b>	<b>Blue/MY425</b>
1		
2		
3		
4		
5		
6		
7		
8		
9		
10		
11		
12		

## Special Instructions:



To order call **1-888-822-9777** or email [csquotes@tab.com](mailto:csquotes@tab.com)

View prices online at [www.shoptab.com](http://www.shoptab.com)

# Indexes - Stock Dividers



## AMES Stock Copy Chart Dividers

Set of eight dividers comes with standard copy printed on both sides of polyester laminated color tabs.

- Overall size: 9" x 11", including 1/2" side tab.
- Made of white tag stock.
- Polyester reinforced top and side holes for use with 3-ring binders or folders with fasteners.

MODEL NO.	LBS./BOX	QUANTITY
TAB-MR	30 lbs.	100 sets/box

TAB	COLOR	TAB TEXT
1	Blue	HISTORY & PHYSICAL
2	Yellow	PROGRESS NOTES
3	Orange	CORRESPONDENCE
4	Green	LAB/X-RAY
5	Red	HOSPITAL
6	Brown	INSURANCE
7	Pink	MISCELLANEOUS
8	Clear/Frosty	blank (writable)



## AMES VNA Tab Dividers

Set of 10 dividers with printed tabs designed to coordinate with our VNA folders.

- Overall size: 9" x 11", including 1/2" tab.
- Made of white tag stock with polyester laminated, color tabs.
- Polyester reinforced top and side holes for use with any folder.

MODEL NO.	LBS./BOX	QUANTITY
TAB-VNA	32 lbs.	100 sets/box

TAB	COLOR	TAB TEXT
1	Blue	ORDERS
2	White	NURSES NOTES
3	Purple	PHYSICAL THERAPY NOTES
4	Pink	SPEECH THERAPY NOTES
5	Yellow	OCCUPATIONAL THERAPY NOTES
6	Green	SOCIAL WORK NOTES
7	Grey	HOME HEALTH AIDE
8	Red	LAB
9	Brown	MISC.
10	Orange	BILLING ANCILLARY / CORRESPONDENCE

## AMES Medical Staff Services Credential Files

Organize your credential files and make the survey process easier and more efficient. Each file is designated as confidential.

- Made of sturdy 25 point pressboard.
- Tyvek® gusset expansion holds up to 2" of documents.
- AMES Easclip (in Position #1, shown right).
- 10 color-categorized tab dividers to a set.
- Folders and dividers sold separately.

MODEL NO.	DESCRIPTION	LBS./BOX	QUANTITY
FLD-MD	Folders	44 lbs.	box of 100
CD-MD	Divider Sets	16 lbs.	box of 50

To Order Custom Folders & Dividers or Divider Installation, call 1-800-343-2040.



TAB	COLOR	TAB TEXT
1	Red	RECOMMENDATIONS/REVIEW & ACTIONS
2	Blue	PRIVILEGES
3	Yellow	APPLICATION
4	Green	REFERENCES/AFFILIATIONS/TRAINING/MED.SCH.
5	White	MALPRACTICE COVERAGE & HISTORY/NPDB OUT OF STATE LICENSE
6	Purple	STATE LICENSE & APP/DEA
7	Pink	ADVANCED CERTIFICATES / CME
8	Grey	INTERNAL REPORTS / REQUIREMENTS
9	Brown	CORRESPONDENCE / MISC.
10	Orange	REFERENCES SENT

# Indexes - Stock Dividers

## AMES "Admission" Tab Dividers

Tab positions 1 through 4 are printed with "Admission 1" through "Admission 4". Reverse side of tabs is printed "Admission" without numbering so you can flip the dividers for use in positions 5 through 8.

- Overall size: 9" x 11", including 1/2" tab.
- Made of white tag stock.
- Eighth-cut tab dividers along long edge.
- Blue polyester laminated tabs with black copy on both sides of tab.
- Choose reinforced top and bottom holes or reinforced side holes.

MODEL NO.	TAB TITLE	HOLE PUNCH POSITIONS	LBS./BOX	QUANTITY
TAB-DIV-ST1	1st Admission	2 hole-punched	8 lbs.	box of 250
TAB-DIV-ST1-SE	1st Admission	4 hole-punched:	8 lbs.	box of 250

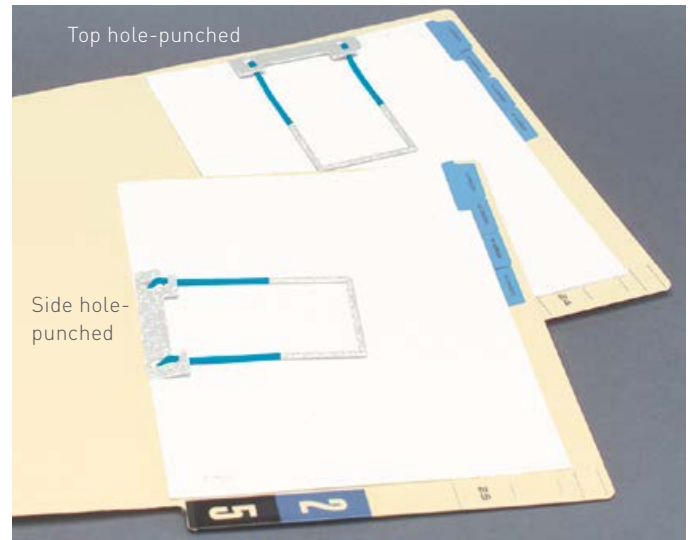

*(Folders and Easyclips sold separately.)*

## AMES Standard Filebacks

An economical way to add charts and reports to existing files.

- Overall size: 8-3/4" x 11-1/4".
- Made of durable 11 point manila stock.
- Factory-attached 2" bonded fastener.

MODEL NO.	LBS./BOX	QUANTITY
FLB-ST	40 lbs.	box of 500

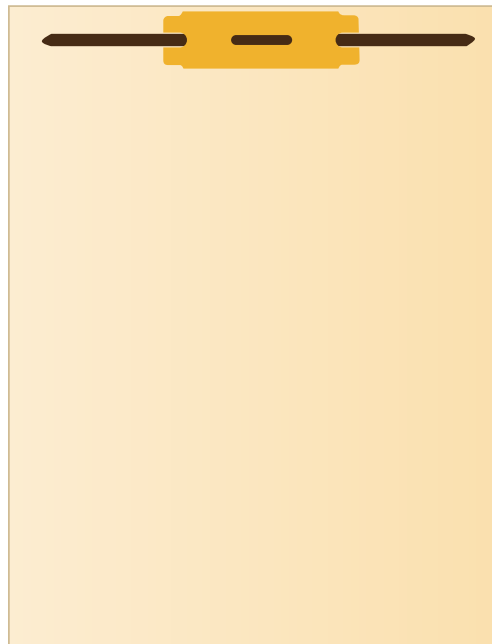

## To Order Custom Filebacks

with scored wings, laminated tabs, and more, call **1-888-822-9777.**

# Alphabetic Labels



1283 & 1286 colors

## Alphacode

Instantly recognize files on a shelf or a desk with these self-adhesive labels. Available in boxes of 500 or sheets of 50

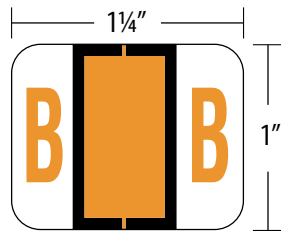

### 1" Color Coded Labels – Boxes

**Alphacode** – Replace \* with desired letter A-Z

MODEL NO.	DESCRIPTION	QUANTITY
1283-*	1" High Alphabetic Color Label	box of 500
1283-50	1" High Alphabetic Color Label Complete Set – 1 box each	1 set

(Mc available as 1283-\* only)

### 1" Color Coded Label – Sheets

**Alphacode** – Replace \* with desired letter A-Z

MODEL NO.	DESCRIPTION	QUANTITY
1286-*	1" High Alphabetic Sheet Labels – 50 labels/sheet	1 sheet
1286-00	1" High Starter Set A to Z (3,100 labels) 100 ea. consonant; 200 ea. vowel	1 set

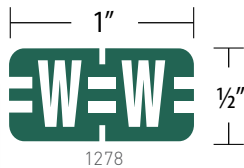

1278

### 1/2" Color Coded Classification Labels

**Alphacode** – Replace \* with desired letter A-Z

MODEL NO.	DESCRIPTION	QUANTITY
1278-*	1/2" High Alphabetic Color Label	box of 500
1278-50	1/2" High Alphabetic Color Label Complete Set – 1 box each	1 set

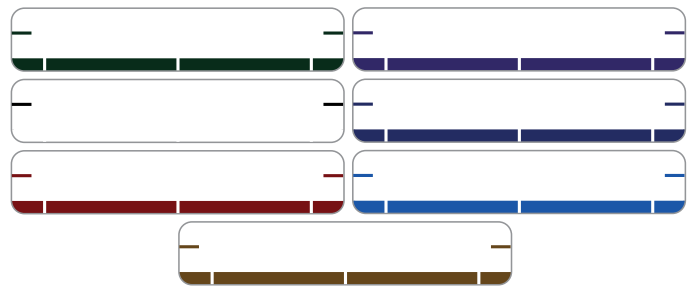
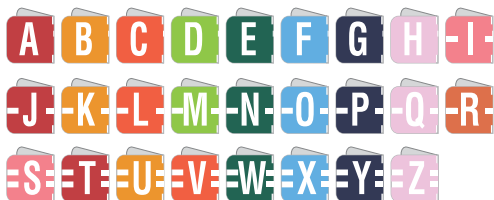

TABSTIK label colors Actual label size is 3 3/8" x 5/8"

### TABSTIK Name Labels

MODEL NO.	DESCRIPTION	QUANTITY	MODEL NO.	DESCRIPTION	QUANTITY
1389-00	Dark Green	box of 504	1303-90	White for Laser Printers	box of 750
1390-00	White	box of 504	1290-00	White Pinfeed Labels	box of 5040
1394-00	Red	box of 504			
1396-00	Purple	box of 504			
1397-00	Dark Blue	box of 504			
1398-00	Light Blue	box of 504			
1401-00	Tan	box of 504			

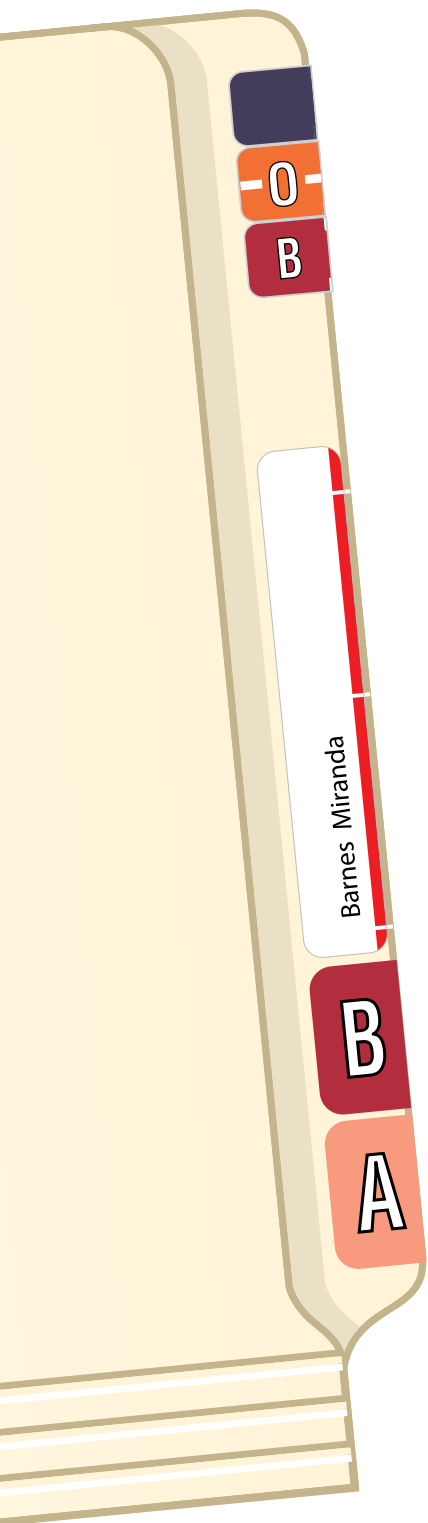

## DataFile® Alphacode

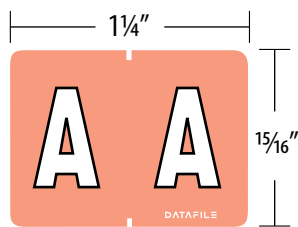

L8720-\*



### Full Size Color Coded Labels - Boxes

**Alphacode** – Replace \* with desired letter A-Z

MODEL NO.	DESCRIPTION	QUANTITY
L8720-*	Alphabetic Color Label	box of 500
L8724	Alphabetic Color Label Complete Set – Box	1 set

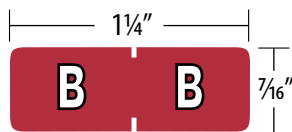

L7701-\*

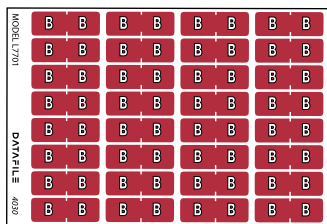

### Half Size Color Coded Labels - Sheets

**Alphacode** – Replace \* with desired letter A-Z

MODEL NO.	DESCRIPTION	QUANTITY
L7701-*	Alphabetic Color Label 32 labels/sheet, 8 sheets/package	1 pkg
L7704	Alphabetic Color Label Complete Set – Sheets	1 set



# Alphabetic Labels

## AMES Jeter® Style 7200 Series Alpha Labels

- Size: 1" x 1-5/8".
- Polyester laminated for added durability.
- Scored to center and fold easily.
- Die cut labels with permanent adhesive and release coated paper backing.
- Packaged in self-dispensing boxes.

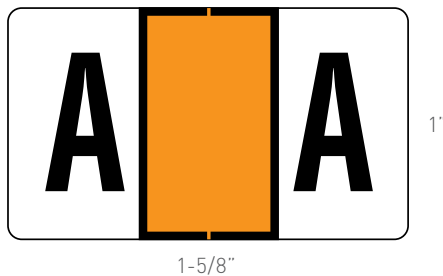

### Individual Boxes

MODEL NO.	LBS./UNIT	QUANTITY
See left	1/2 lb.	box of 500

### Label Sets (1 box of each letter + Mc)

L-J-ALPHA-ST	13 lbs.	27 boxes/set
--------------	---------	--------------

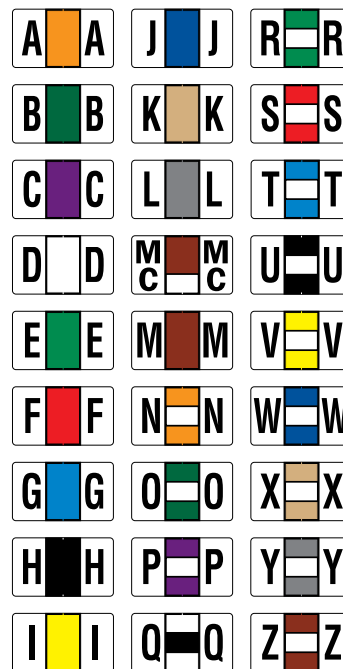

MODEL NO./LETTER	COLOR	
L-J-ALPHA-A	Orange	A
L-J-ALPHA-B	Dark Green	B
L-J-ALPHA-C	Purple	C
L-J-ALPHA-D	White	D
L-J-ALPHA-E	Light Green	E
L-J-ALPHA-F	Red	F
L-J-ALPHA-G	Light Blue	G
L-J-ALPHA-H	Black	H
L-J-ALPHA-I	Yellow	I
L-J-ALPHA-J	Dark Blue	J
L-J-ALPHA-K	Tan	K
L-J-ALPHA-L	Grey	L
L-J-ALPHA-M	Brown	M
L-J-ALPHA-MC	Brown/White	Mc
L-J-ALPHA-N	Orange	N
L-J-ALPHA-O	Dark Green	O
L-J-ALPHA-P	Purple	P
L-J-ALPHA-Q	White	Q
L-J-ALPHA-R	Light Green	R
L-J-ALPHA-S	Red	S
L-J-ALPHA-T	Light Blue	T
L-J-ALPHA-U	Black	U
L-J-ALPHA-V	Yellow	V
L-J-ALPHA-W	Dark Blue	W
L-J-ALPHA-X	Tan	X
L-J-ALPHA-Y	Grey	Y
L-J-ALPHA-Z	Brown	Z

## AMES TAB® Style Full Size 1283 Series Alpha Labels

- Size: 1" x 1-5/8".
- Compatible with TAB series 1283.
- Polyester laminated for added durability.
- Scored to center and fold easily.
- Die cut labels with permanent adhesive and release coated paper backing.
- Packaged in self-dispensing boxes.

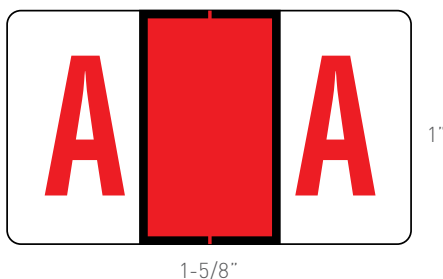

### Individual Boxes

MODEL NO.	LBS./UNIT	QUANTITY
See left	1/2 lb.	box of 500

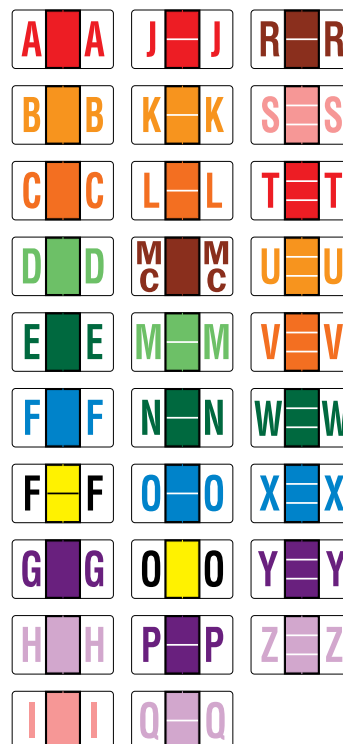

MODEL NO./LETTER	COLOR	
L-T-ALPHA-A	Red	A
L-T-ALPHA-B	Light Orange	B
L-T-ALPHA-C	Dark Orange	C
L-T-ALPHA-D	Light Green	D
L-T-ALPHA-E	Dark Green	E
L-T-ALPHA-F	Blue	F
L-T-ALPHA-G	Purple	G
L-T-ALPHA-H	Lavender	H
L-T-ALPHA-I	Pink	I
L-T-ALPHA-J	Red	J
L-T-ALPHA-K	Light Orange	K
L-T-ALPHA-L	Dark Orange	L
L-T-ALPHA-M	Light Green	M
L-T-ALPHA-MC	Brown	Mc
L-T-ALPHA-N	Dark Green	N
L-T-ALPHA-O	Blue	O
L-T-ALPHA-P	Purple	P
L-T-ALPHA-Q	Lavender	Q
L-T-ALPHA-R	Brown	R
L-T-ALPHA-S	Pink	S
L-T-ALPHA-T	Red	T
L-T-ALPHA-U	Light Orange	U
L-T-ALPHA-V	Dark Orange	V
L-T-ALPHA-W	Dark Green	W
L-T-ALPHA-X	Blue	X
L-T-ALPHA-Y	Purple	Y
L-T-ALPHA-Z	Lavender	Z



# Alphabetic Labels

## AMES Small Alpha Labels

- Size: 1-7/8" x 1".
- Polyester laminated for added durability.
- Scored to center and fold easily.
- Die cut labels with permanent adhesive and release coated paper backing.
- Packaged in self-dispensing boxes.

### Individual Boxes

MODEL NO.	LBS./UNIT	QUANTITY
See right	1/2 lb.	box of 500

### Label Sets (1 box of each letter)

L-A-ALPHA-ST	13 lbs.	1 set - 26 boxes
--------------	---------	------------------



MODEL NO./LETTER	COLOR	
L-A-ALPHA-A	AMES Red	A
L-A-ALPHA-B	AMES Grey	B
L-A-ALPHA-C	AMES Blue	C
L-A-ALPHA-D	AMES Orange	D
L-A-ALPHA-E	AMES Purple	E
L-A-ALPHA-F	Light Green	F
L-A-ALPHA-G	AMES Yellow	G
L-A-ALPHA-H	AMES Brown	H
L-A-ALPHA-I	AMES Pink	I
L-A-ALPHA-J	AMES Green	J
L-A-ALPHA-K	Violet	K
L-A-ALPHA-L	Tan	L
L-A-ALPHA-M	Salmon	M
L-A-ALPHA-N	AMES Red	N
L-A-ALPHA-O	AMES Grey	O
L-A-ALPHA-P	AMES Blue	P
L-A-ALPHA-Q	AMES Orange	Q
L-A-ALPHA-R	AMES Purple	R
L-A-ALPHA-S	Light Green	S
L-A-ALPHA-T	AMES Yellow	T
L-A-ALPHA-U	AMES Brown	U
L-A-ALPHA-V	AMES Pink	V
L-A-ALPHA-W	AMES Green	W
L-A-ALPHA-X	Violet	X
L-A-ALPHA-Y	Tan	Y
L-A-ALPHA-Z	Salmon	Z

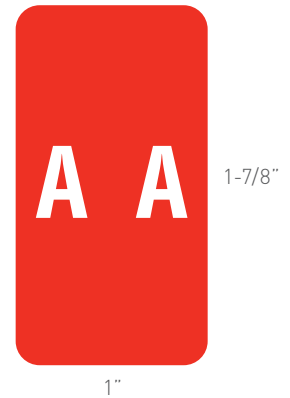

## AMES Large Alpha Labels

- Size: 1-7/8" x 1-7/8".
- Made from synthetic latex stock for greater flexibility.
- Permanent adhesive and release coated paper backing.
- Packaged in self-dispensing boxes.

### Individual Boxes

MODEL NO.	LBS./UNIT	QUANTITY
See right	1 lb.	box of 500

### Label Sets (1 box of each letter)

L178ST	26 lbs.	1 set - 26 boxes
--------	---------	------------------



MODEL NO./LETTER	COLOR	
L178A	AMES Red	A
L178B	AMES Grey	B
L178C	AMES Blue	C
L178D	AMES Orange	D
L178E	AMES Purple	E
L178F	Light Green	F
L178G	AMES Yellow	G
L178H	AMES Brown	H
L178I	AMES Pink	I
L178J	AMES Green	J
L178K	Violet	K
L178L	Tan	L
L178M	Salmon	M
L178N	AMES Red	N
L178O	AMES Grey	O
L178P	AMES Blue	P
L178Q	AMES Orange	Q
L178R	AMES Purple	R
L178S	Light Green	S
L178T	AMES Yellow	T
L178U	AMES Brown	U
L178V	AMES Pink	V
L178W	AMES Green	W
L178X	Violet	X
L178Y	Tan	Y
L178Z	Salmon	Z



# Numeric Labels



## Compucolor

Social Security Numbers, Account Numbers, Credit Cards, Zip Codes invoice number, dates can all be identified with these self adhesive numeric color coding labels. Available in boxes of 500.

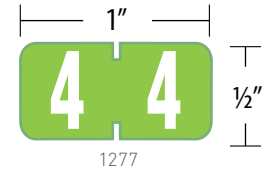
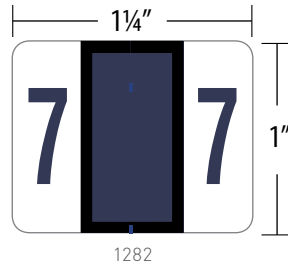

**1" High Compucolor** – Replace \* with desired number 0 - 9

MODEL NO.	DESCRIPTION	QUANTITY
1282-*	1" High Numeric Color Label	roll of 500/box
1282-50	1" High Numeric Color Label Complete Set – 1 box each	1 set

**1/2" High Compucolor** – Replace \* with desired number 0 - 9

MODEL NO.	DESCRIPTION	QUANTITY
1277-*	1/2" High Numeric Color Label	roll of 500/box
1277-50	1/2" High Numeric Color Label Complete Set 0 to 9 Box	1 set



# Numeric Labels

## AMES Numeric Color Coded Labels

Reduce misfiles with color coding. A break in the color pattern instantly signals a misfile. Two color bars reduce the potential for misfiles to within 1% of the total file; three color bars to within 1/10%.

### AMES 1-7/8" Large Digit Reverse-Block Numeric Labels

- Size: 1-7/8" x 1-7/8".
- Choose standard synthetic latex or polyester laminated labels.
- Features permanent adhesive and release coated paper backing.
- Packaged in self-dispensing boxes.



1-7/8" x 1-7/8"

#### Individual Digit Boxes

ITEM DESCRIPTION	LBS./UNIT	QUANTITY
Standard	1 lb.	box of 1000
Laminated	1 lb.	box of 500

#### Label Sets (1 box each of 10 AMES colors)

Standard	10 lbs.	1 set of 10 boxes
Laminated	10 lbs.	1 set of 10 boxes

STANDARD MODEL NO.	LAMINATED MODEL NO.	COLOR	DIGIT
L-A-00178RL	L-A-00178RPL	AMES Red	0
L-A-01178RL	L-A-01178RPL	AMES Grey	1
L-A-02178RL	L-A-02178RPL	AMES Blue	2
L-A-03178RL	L-A-03178RPL	AMES Orange	3
L-A-04178RL	L-A-04178RPL	AMES Purple	4
L-A-05178RL	L-A-05178RPL	AMES Black	5
L-A-06178RL	L-A-06178RPL	AMES Yellow	6
L-A-07178RL	L-A-07178RPL	AMES Brown	7
L-A-08178RL	L-A-08178RPL	AMES Pink	8
L-A-09178RL	L-A-09178RPL	AMES Green	9
L-A-ST178RL	L-A-ST178RPL	Label Set	0-9



### AMES 1-7/8" Small Digit Reverse-Block Numeric Labels

- Size: 1-7/8" x 1-7/8".
- Made from synthetic latex stock for greater flexibility and longer life.
- Features permanent adhesive and release coated paper backing.
- Packaged in self-dispensing boxes.

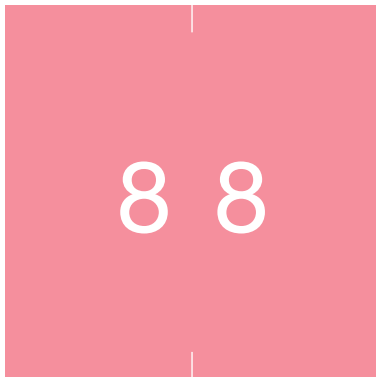

1-7/8" x 1-7/8"



#### Individual Digit Boxes

MODEL NO.	LBS./UNIT	QUANTITY
See below	1 lb.	box of 1000

#### Label Sets (1 box each of 10 AMES colors)

L-A-ST178RS	10 lbs.	1 set of 10 boxes
-------------	---------	-------------------

MODEL NO.	COLOR	DIGIT
L-A-00178RS	AMES Red	0
L-A-01178RS	AMES Grey	1
L-A-02178RS	AMES Blue	2
L-A-03178RS	AMES Orange	3
L-A-04178RS	AMES Purple	4
L-A-05178RS	AMES Black	5
L-A-06178RS	AMES Yellow	6
L-A-07178RS	AMES Brown	7
L-A-08178RS	AMES Pink	8
L-A-09178RS	AMES Green	9
L-A-ST178RS	Label Set	0-9

### AMES 9/16" x 1-3/4" Reverse-Block Numeric Labels

- Size: 9/16" x 1-3/4".
- Made from synthetic latex for greater flexibility.
- Features permanent adhesive and release coated paper backing.
- Labels come in rolls.



1-3/4"

#### Individual Digit Rolls

MODEL NO.	LBS./UNIT	QUANTITY
See below	1/2 lb.	roll of 1000

#### Label Sets (1 roll each of 10 AMES colors)

L-A-ST134RB	5 lbs.	1 set of 10 rolls
-------------	--------	-------------------

MODEL NO.	COLOR	DIGIT
L-A-00134RB	AMES Red	0
L-A-01134RB	AMES Grey	1
L-A-02134RB	AMES Blue	2
L-A-03134RB	AMES Orange	3
L-A-04134RB	AMES Purple	4
L-A-05134RB	AMES Black	5
L-A-06134RB	AMES Yellow	6
L-A-07134RB	AMES Brown	7
L-A-08134RB	AMES Pink	8
L-A-09134RB	AMES Green	9
L-A-ST134RB	Label Set	0-9



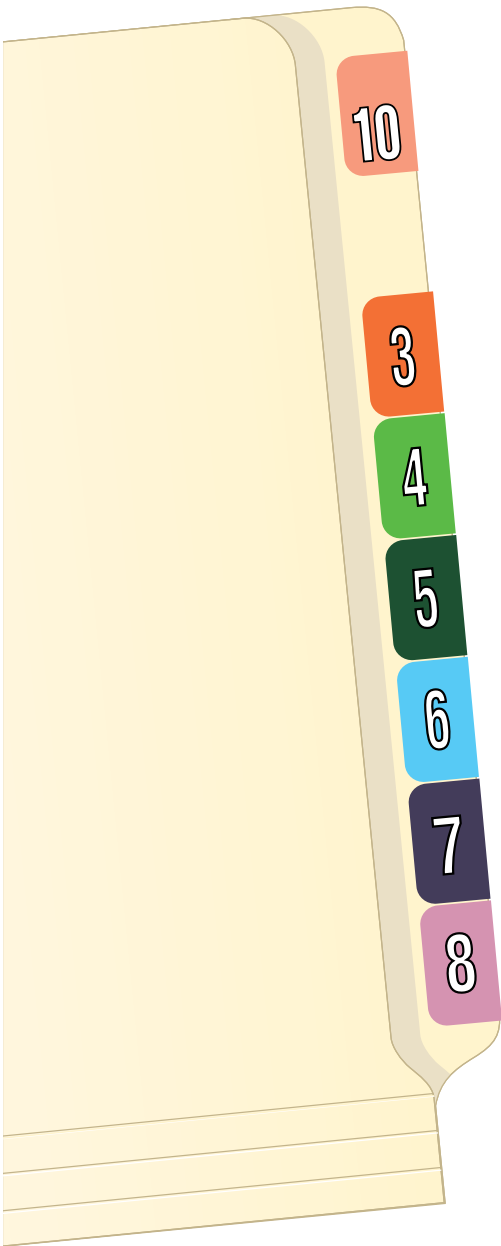

## Datafile® Numeric Labels

Social Security Numbers, Account Numbers, Credit Cards, Zip Codes invoice number, and dates can all be identified with these self adhesive numeric color coding labels. Available in boxes of 500.

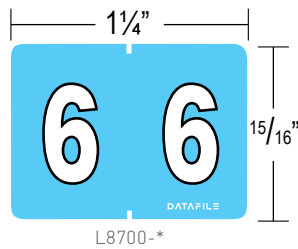

**Full Size Numeric** – Replace \* with desired number 0-9

MODEL NO.	DESCRIPTION	QUANTITY
L8700-*	Numeric Color Label	box of 500
L8706	Numeric Color Label Complete Set 0-9	1 set

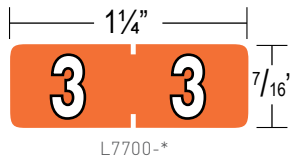

**Half Size Numeric** – Replace \* with desired number 0-9

MODEL NO.	DESCRIPTION	QUANTITY
L7700-*	Numeric Color Label	box of 500

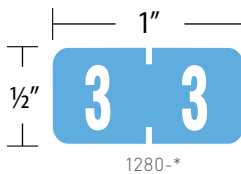

**TABSTIK Numeric** – Replace \* with desired number 0-9

MODEL NO.	DESCRIPTION	QUANTITY
1280-*	1/2" High TABSTIK Numeric Classification Labels	roll of 1000
1280-50	1/2" High Numeric Color Label Classification Labels Complete Set 0-9	set



# Numeric Labels

## AMES TAB® Style Full Size Numeric Labels

- Compatible with TAB systems.
- Size: 1" x 1-5/8".
- Polyester laminated for added durability.
- Scored to center and fold easily.
- Die cut labels with permanent adhesive and release coated paper backing.
- Packaged in self-dispensing boxes.

### Individual Digit Boxes

MODEL NO.	LBS./UNIT	QUANTITY
See right	1/2 lb.	box of 500

### Label Sets (1 box each of 10 colors)

L-T-ST158	5 lbs.	1 set of 10 boxes
-----------	--------	-------------------

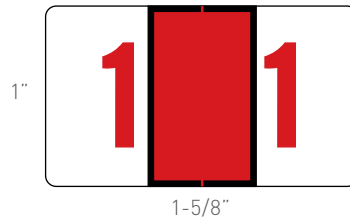

MODEL NO.	COLOR	DIGIT
L-T-00158	Pink	0
L-T-01158	Red	1
L-T-02158	Light Orange	2
L-T-03158	Dark Orange	3
L-T-04158	Light Green	4
L-T-05158	Dark Green	5
L-T-06158	Blue	6
L-T-07158	Purple	7
L-T-08158	Lavender	8
L-T-09158	Brown	9
L-T-ST158	Label Set	0-9

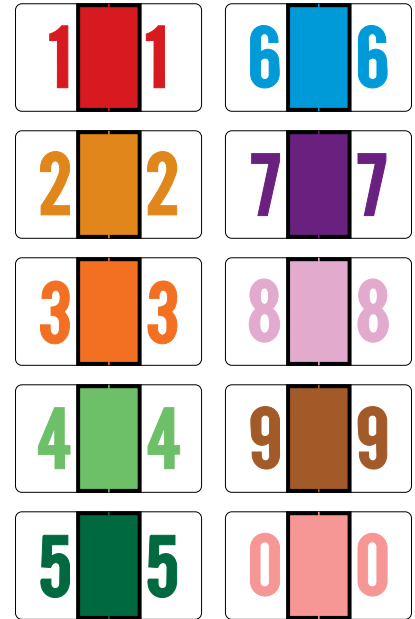

## AMES Jeter® Style 7300 Series Numeric

- Compatible with Jeter systems.
- Size: 1" x 1-5/8".
- Polyester laminated for added durability.
- Scored to center and fold easily.
- Die cut labels with permanent adhesive and release coated paper backing.
- Packaged in self-dispensing boxes.

### Individual Digit Boxes

MODEL NO.	LBS./UNIT	QUANTITY
See right	1/2 lb.	box of 500

### Label Sets (1 box each of 10 colors)

L-J-ST158	5 lbs.	1 set of 10 boxes
-----------	--------	-------------------

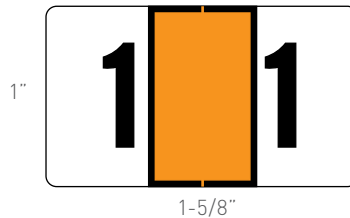

MODEL NO.	COLOR	DIGIT
L-J-00158	Tan	0
L-J-01158	Orange	1
L-J-02158	Dark Green	2
L-J-03158	Purple	3
L-J-04158	Light Blue	4
L-J-05158	Red	5
L-J-06158	Light Green	6
L-J-07158	Black	7
L-J-08158	Yellow	8
L-J-09158	Dark Blue	9
L-J-ST158	Label Set	0-9

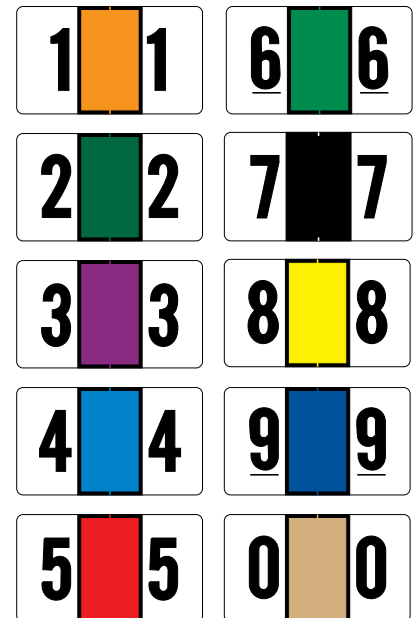

# Top TAB Labels

## Alphabetic Labels

Instantly recognize files on a shelf or a desk with these self-adhesive labels. Available in boxes of 500.

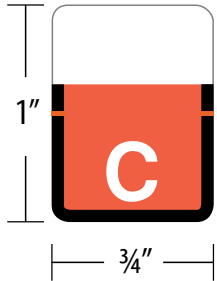

### Top Tab Alphabetic Labels

**Alphacode** – Replace \* with desired letter A-Z

MODEL NO.	DESCRIPTION	QUANTITY
1307-*	1" High Alphabetic Color Label	box of 500
1307-50	1" High Alphabetic Color Label Complete Set A-Z	1 set



## Numeric Labels

Social Security Numbers, Account Numbers, Credit Cards, Zip Codes invoice number, and dates can all be identified with these self adhesive numeric color coding labels. Available in boxes of 500.

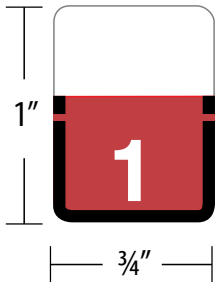

### Top Tab Numeric Labels

**Numeric** – Replace \*\* with desired number 0-9

MODEL NO.	DESCRIPTION	QUANTITY
1306-**	1" High Numeric Color Label	box of 500
1306-50	1" High Numeric Color Label Complete Set 0-9	1 set



## Year Labels

### Top Tab Year Code Labels

**Year Code** – Replace \*\* with desired year code

MODEL NO.	DESCRIPTION	QUANTITY
1308-**	1 1/8" High 2 Digit Year Code	box of 500

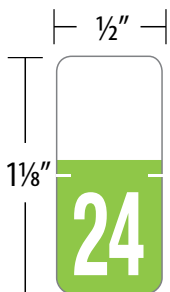



# Solid Color Labels

## Solid Color Labels

Replace \*\* with desired color number

MODEL NO.	DESCRIPTION	QUANTITY
1281-**	1/2" High Solid Color Classification Labels	box of 1000
1281-50	1/2" High Solid Color Classification Labels (12 colors)	1 set

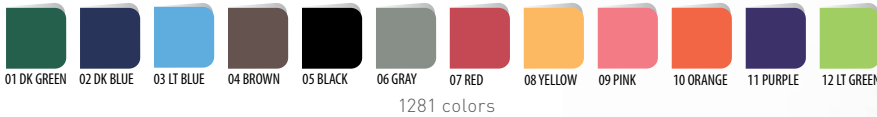
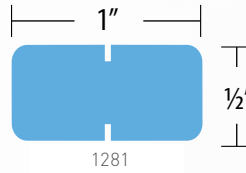

## AMES Solid Block Color Labels

- Available in two sizes: 1-7/8" x 1-7/8" and 9/16" x 1-3/4"
- Made from synthetic latex stock for greater flexibility and longer life.
- Features permanent adhesive and release coated paper backing.
- 1-7/8" labels come in self-dispensing boxes; 1/2" labels come in rolls.

### Individual Colors

MODEL NO.	DESCRIPTION	LBS./UNIT	QUANTITY
See Chart (large)	1-7/8" x 1-7/8"	1 lb.	box of 1000
See Chart (small)	9/16" x 1-3/4"	1/2 lb.	roll of 1000

LARGE 1-7/8" x 1-7/8"		SMALL 9/16" x 1-3/4"		COLOR
MODEL NO.	MODEL NO.			
L-A-00178	L-A-00134			AMES Red
L-A-01178	L-A-01134			AMES Grey
L-A-02178	L-A-02134			AMES Blue
L-A-03178	L-A-03134			AMES Orange
L-A-04178	L-A-04134			AMES Purple
L-A-05178	L-A-05134			AMES Black
L-A-06178	L-A-06134			AMES Yellow
L-A-07178	L-A-07134			AMES Brown
L-A-08178	L-A-08134			AMES Pink
L-A-09178	L-A-09134			AMES Green
—	L-A-0A134			Aqua
—	L-A-0G134			Gold
L-A-0T178	L-A-0T134			Natural Wallet
L-A-0W178	L-A-0W134			White
L-A-ST178	L-A-ST134			AMES Colors Only

### Label Sets (1 box/roll each of 10 AMES colors)

L-A-ST178 (large)	1-7/8" x 1-7/8"	10 lbs.	1 set of 10 boxes
L-A-ST134 (small)	9/16" x 1-3/4"	10 rolls/set	1 set of 10 rolls



1-7/8" square

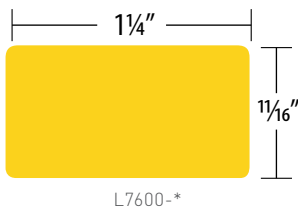

## DataFile® Solid Color Labels

Replace \* with desired color number

MODEL NO.	DESCRIPTION	QUANTITY
L7600-*	Solid Color label	box of 500



# Label Accessories

## Label Organizer Box

Label organizer box holds individual boxes for organizing CompuColor, AlphaCode, Classification, Year, Month, Solid and Color-Bar labels.

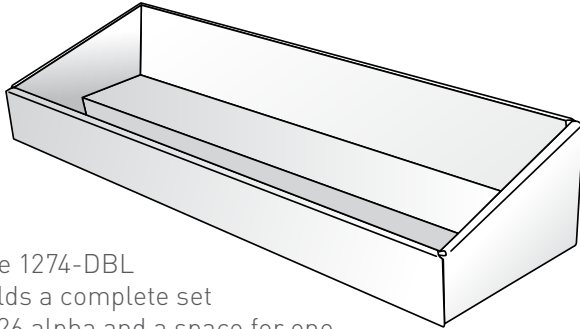

The 1274-DBL holds a complete set of 26 alpha and a space for one additional box to add a year label or the Mc label.

MODEL NO.	DESCRIPTION	QUANTITY
1274-DBL	Double Organizer Box	10

\*[1] Organizer box included at N/C with each label set purchased.

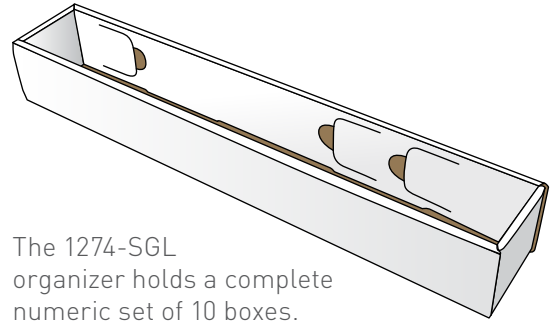

The 1274-SGL organizer holds a complete numeric set of 10 boxes.

MODEL NO.	DESCRIPTION	QUANTITY
1274-SGL	Single Organizer Box	1

\*[1] Organizer box included at N/C with each label set purchased.

## Label Protectors

Extend your shelf life with clear wrap around self adhesive label protectors.

MODEL NO.	DESCRIPTION	QUANTITY
4400-00	2" w x 4" h	500/pkg
4401-00	2" w x 8" h	100/pkg

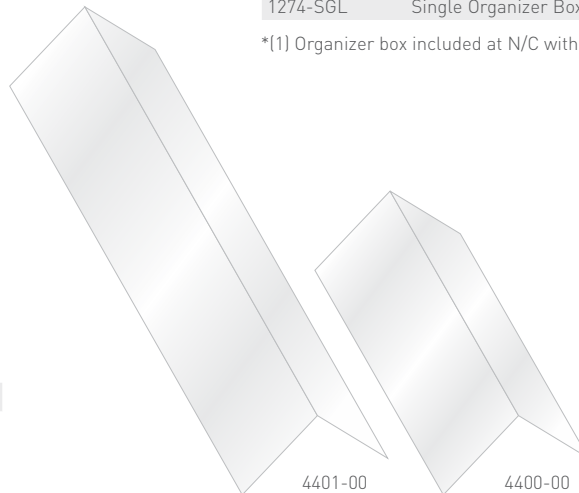

## Custom Printed Label

Custom printed strip labels can be printed vertically or horizontally in black ink. When ordering, specify vertical or horizontal and the print copy desired. Maximum digits horizontally is 3 and vertically is 6. 500 labels/box.

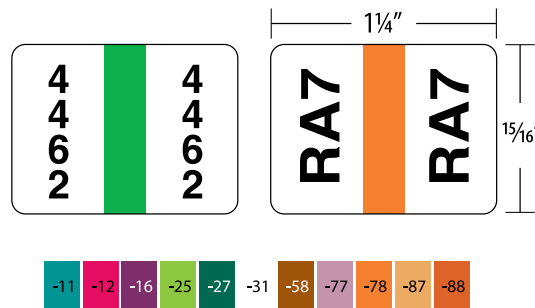

MODEL NO.	DESCRIPTION	QUANTITY
DF737-11	Light Blue	box of 500
DF737-12	Red	box of 500
DF737-16	Purple	box of 500
DF737-25	Light Green	box of 500
DF737-27	Dark Green	box of 500
DF737-31	White	box of 500
DF737-58	Brown	box of 500
DF737-77	Lavender	box of 500
DF737-78	Pink	box of 500
DF737-87	Light Orange	box of 500
DF737-88	Dark Orange	box of 500

# Month/Year Labels

## DataFile® Year Labels – Box

Replace \*\* with desired year number

MODEL NO.	DESCRIPTION	QUANTITY
L8800-**-	2 Digit Year Labels	box of 500

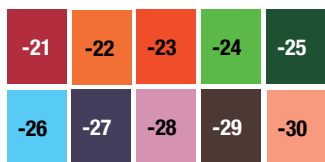
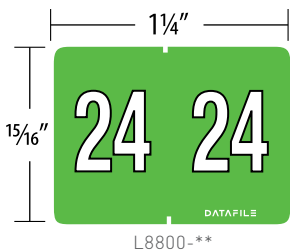

## Year Labels

MODEL NO.	DESCRIPTION	QUANTITY
1287-**-	1/2" High 2 Digit Year Label (replace ** with number of year desired)	roll of 500
1309-**-	1" High 2 Digit Year Label (replace ** with number of year desired)	roll of 500

## DataFile® Month Labels – Sheet

Replace \*\* with desired month number

MODEL NO.	DESCRIPTION	QUANTITY
L8801-**-	Month Sheet Labels 16 Label/sheet, 15 sheets/pkg	1 pkg

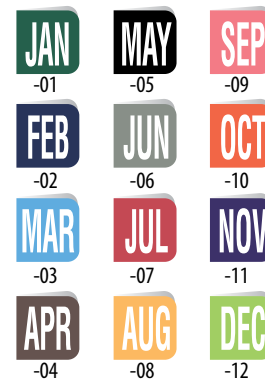
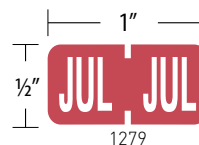
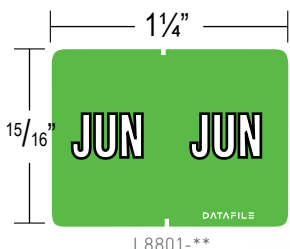

## Month Labels

MODEL NO.	DESCRIPTION	QUANTITY
1279-**-	1/2" High Month Label (replace ** with number of month desired)	box of 1000
1279-50	1/2" High Month Label	1 set

# Year Labels

## AMES Large Year Code Labels

- Size: 1-7/8" x 1-7/8".
- Made from synthetic latex stock for greater flexibility and longer life.
- Permanent adhesive.
- Release coated paper backing.
- Packaged in self-dispensing boxes.

### Individual Boxes

MODEL NO.	LBS./BOX	QUANTITY
See right	1 lb.	box of 1000

MODEL NO.	COLOR	YEAR
L-A-DD21R178	Gray	2021
L-A-DD22R178	Blue	2022
L-A-DD23R178	Orange	2023
L-A-DD24R178	Purple	2024
L-A-DD25R178	Black	2025
L-A-DD26R178	Yellow	2026
L-A-DD27R178	Brown	2027
L-A-DD28R178	Pink	2028
L-A-DD29R178	Green	2029
L-A-DD30R178	Red	2030

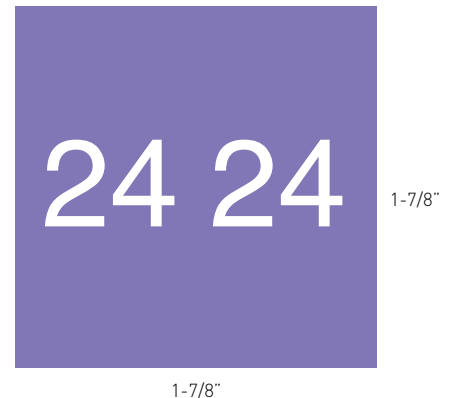

## AMES Small Year Code Labels

- Size: 9/16" x 1-3/4".
- Made from synthetic latex stock for greater flexibility and longer life.
- Permanent adhesive.
- Release coated paper backing.
- Labels come in rolls.

### Individual Rolls

MODEL NO.	LBS./ROLL	QUANTITY
See right	1/2 lb.	roll of 1000

MODEL NO.	COLOR	YEAR
L-A-DD21R134	Gray	2021
L-A-DD22R134	Blue	2022
L-A-DD23R134	Orange	2023
L-A-DD24R134	Purple	2024
L-A-DD25R134	Black	2025
L-A-DD26R134	Yellow	2026
L-A-DD27R134	Brown	2027
L-A-DD28R134	Pink	2028
L-A-DD29R134	Green	2029
L-A-DD30R134	Red	2030

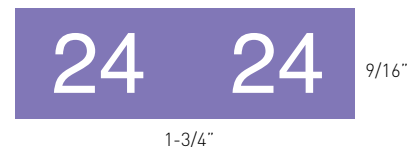

## AMES TAB® Style Mini Year Code Labels

- Size: 1/2" x 1".
- Die cut labels with permanent adhesive.
- Release coated paper backing.
- Labels come in shrink-wrapped rolls.

### Individual Rolls

MODEL NO.	LBS./ROLL	QUANTITY
See right	1/2 lb.	roll of 500

MODEL NO.	COLOUR	YEAR
L-A-TYR21	Red	2021
L-A-TYR22	Orange	2022
L-A-TYR23	Gray	2023
L-A-TYR24	Emerald	2024
L-A-TYR25	Dk Green	2025
L-A-TYR26	Blue	2026
L-A-TYR27	Purple	2027
L-A-TYR28	Lilac	2028
L-A-TYR29	Brown	2029
L-A-TYR30	Pink	2030



# Month/Year Labels

## AMES Month/Year Code Labels

- Size: 1" x 1-3/4"
- Polyester laminated for added durability.
- Scored to center and fold easily.
- Permanent adhesive and release coated paper backing.
- Labels come in rolls.

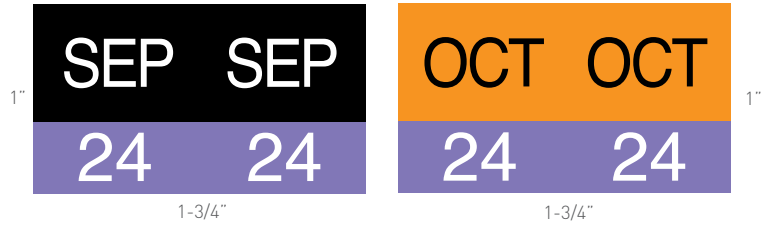

2019 (Green)	2020 (Red)	2021 (Gray)	2022 (Blue)	2023 (Orange)		
ITEM NUMBER	ITEM NUMBER	ITEM NUMBER	ITEM NUMBER	ITEM NUMBER	MONTH COLOR	MONTH
L-A-MY-JAN19	L-A-MY-JAN20	L-A-MY-JAN21	L-A-MY-JAN22	L-A-MY-JAN23	AMES Gray	January
L-A-MY-FEB19	L-A-MY-FEB20	L-A-MY-FEB21	L-A-MY-FEB22	L-A-MY-FEB23	AMES Blue	February
L-A-MY-MAR19	L-A-MY-MAR20	L-A-MY-MAR21	L-A-MY-MAR22	L-A-MY-MAR23	AMES Green	March
L-A-MY-APR19	L-A-MY-APR20	L-A-MY-APR21	L-A-MY-APR22	L-A-MY-APR23	AMES Purple	April
L-A-MY-MAY19	L-A-MY-MAY20	L-A-MY-MAY21	L-A-MY-MAY22	L-A-MY-MAY23	White	May
L-A-MY-JUN19	L-A-MY-JUN20	L-A-MY-JUN21	L-A-MY-JUN22	L-A-MY-JUN23	AMES Yellow	June
L-A-MY-JUL19	L-A-MY-JUL20	L-A-MY-JUL21	L-A-MY-JUL22	L-A-MY-JUL23	AMES Brown	July
L-A-MY-AUG19	L-A-MY-AUG20	L-A-MY-AUG21	L-A-MY-AUG22	L-A-MY-AUG23	AMES Pink	August
L-A-MY-SEP19	L-A-MY-SEP20	L-A-MY-SEP21	L-A-MY-SEP22	L-A-MY-SEP23	AMES Black	September
L-A-MY-OCT19	L-A-MY-OCT20	L-A-MY-OCT21	L-A-MY-OCT22	L-A-MY-OCT23	AMES Orange	October
L-A-MY-NOV19	L-A-MY-NOV20	L-A-MY-NOV21	L-A-MY-NOV22	L-A-MY-NOV23	Aqua	November
L-A-MY-DEC19	L-A-MY-DEC20	L-A-MY-DEC21	L-A-MY-DEC22	L-A-MY-DEC23	AMES Red	December
L-A-MY-ST19	L-A-MY-ST20	L-A-MY-ST21	L-A-MY-ST22	L-A-MY-ST23	Label Set	Jan.-Dec.

### Individual Rolls

MODEL NO.	LBS./UNIT	QUANTITY
See above	1 lb.	roll of 1000

### Label Sets (1 roll of each month)

MODEL NO.	LBS./UNIT	QUANTITY
See above	12 lbs.	1 set of 12 rolls

## AMES Month Labels

- Size: 9/16" x 1-3/4"
- Scored to center and fold easily.
- Polyester laminated for added durability.
- Labels come in rolls.
- Permanent adhesive; release coated paper backing.

### Individual Rolls

MODEL NO.	LBS./UNIT	QUANTITY
See right	1/2 lb.	roll of 1000

### Label Sets (1 roll of each month)

L-A-MST	6 lbs.	1 set of 12 rolls
---------	--------	-------------------



MODEL NO.	MONTH COLOR	MONTH
L-A-MJAN	AMES Grey	January
L-A-MFEB	AMES Blue	February
L-A-MMAR	AMES Green	March
L-A-MAPR	AMES Purple	April
L-A-MMAY	White	May
L-A-MJUN	AMES Yellow	June
L-A-MJUL	AMES Brown	July
L-A-MAUG	AMES Pink	August
L-A-MSEP	AMES Black	September
L-A-MOCT	AMES Orange	October
L-A-MNOV	Aqua	November
L-A-MDEC	AMES Red	December
L-A-MST	Label Set	Jan.-Dec.

## Labels

Purchase -CLCOM Labels to use with TABQUIK.com software.



Label Size  
7.75"x1.66"

7 Labels/Sheet	Labels/Box
6304-00 (Inkjet)	1750
6304-00-CLCOM	1750

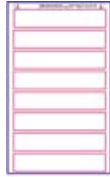

Label Size  
7.75"x1.66"

8 Labels/Sheet	Labels/Box
6307-00 (Inkjet)	400
6307-00-CLCOM	400



Label Size  
7.75"x1.66"

5 Labels/Sheet	Labels/Box
6321-00 (Laser)	1500
6321-00-CLCOM	1500
6324-00 (Inkjet)	500
6324-00-CLCOM	500



Label Size  
7.75"x1.66"  
(Inkjet)

6 Labels/Sheet	Labels/Box
6324-HA (Inkjet)	1800
6324-HA-CLCOM	1800
6324-HA50	300
6324-HA50-CLCOM	300



Label Size  
7.75"x1.66"  
(Laser)

6 Labels/Sheet	Labels/Box
6321-HA	1800
6321-HA-CLCOM	1800
6321-HA50	300
6321-HA50-CLCOM	300



Label Size  
8"x1.5"

6 Labels/Sheet	Labels/Box
6376-00 (Inkjet)	1500
6376-50 (Inkjet)	300
6376-00-CLCOM	1500
6376-50-CLCOM	300
6379-00 (Laser)	1500
6379-50 (Laser)	300
6379-00-CLCOM	1500
6379-50-CLCOM	300



Label Size  
4-8"x1.5"  
and  
4-3.87"x1.5"

4 sets of 2 Labels/Sheet	Sheets/Box
6380-00 (Laser)	250
6380-00-CLCOM	250



Label Size  
8"x1.5"  
notched

6 Labels/Sheet	Labels/Box
6378-00 (Inkjet)	1500
6378-00-CLCOM	1500



Label Size  
6.75"x1.66"

6 Labels/Sheet	Labels/Box
6443-00 (laser)	1800
6443-00-CLCOM	1800



Label Size  
8"x1.5"

6 Labels/Sheet	Labels/Box
6408-00 (Inkjet)	1500
6408-50 (Inkjet)	300
6408-00-CLCOM	1500
6408-50-CLCOM	300
6384-00 (Laser)	1500
6384-50 (Laser)	300
6384-00-CLCOM	1500
6384-50-CLCOM	300

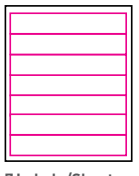

Label Size  
8"x1-7/16"

7 Labels/Sheet	Labels/Box
6412-00 (Laser)	1008
6412-00-CLCOM (Laser)	1008
6413-00 (Inkjet)	1008
6413-00-CLCOM	1008

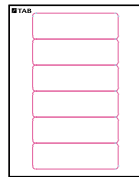

Label Size  
5.5"x1.66"

6 Labels/Sheet	Labels/Box
6446-00 (Inkjet)	300
6446-00-CLCOM	300
6447-00 (Laser)	300
6447-00-CLCOM	300



Label Size 7.75"x1.66" #10 Envelope Size	Labels/Box
2 Labels	
6405-00 (Laser)	200
6405-00-CLCOM	200
6410-00	200
6410-00-CLCOM	200

Additional Labels that are Available but Templates Not Shown on this Page:

Label Size 7.75"x1.66" #10 Envelope Size	Labels/Box
1 Labels/Sheet	
6406-00 (Laser)	100



Label Size 8"x1.5"	Labels/Box
1 Label/Sheet	
6453-00 CLCOM	100



Label Size 4"x1.5" Perfed Middle	Labels/Box
14 Labels/Sheet	
6414-00 (Laser)	100

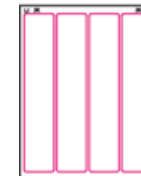

Label Size 8.75"x1.875"	Labels/Box
4 Labels/Sheet	
6444-00 (Inkjet)	1000
6445-00 (Laser)	1000
6445-00-CLCOM	1000

Additional Labels that are Available but Templates Not Shown on this Page:

Model	Labels/Sheet	Label Size	Labels/Box
6304-20	7 Labels/sheet	6.25" x 1.66"	1750 Labels/box (Inkjet)
6352-00	12 Labels/sheet	3.875" x 1.66"	3600 Labels/box (Inkjet)
6403-00	6403-00-CLCOM	12 Labels/sheet	3.875" x 1.66"
			3600 Labels/box (Laser)
6400-00	6400-00-CLCOM	4 X-ray Labels/sheet	10" x 1.875"
			1000 Labels/box (Inkjet)
6406-00	6406-00-CLCOM	1 Label/sheet	#10 Envelope (7.75"x1.66")
			100 Labels/box (Laser)
6381-00	6381-00-CLCOM	4 Labels/sheet	8" x 2.5625" Opaque
			1000 Labels/box (Laser)

\*Note: Label models that end with -CLCOM are the required labels to order with the TABQUIK Internet Version software 6800-COM launched September 1, 2011. Please contact us for details on pricing and a demonstration of the TABQUIK.com software.

## Top/Side Conversion

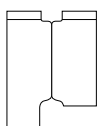

4302-01

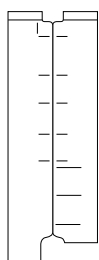

4302-50

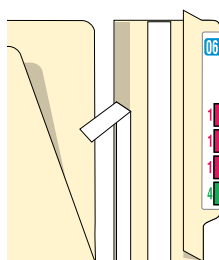

4302-DPT

## Convert-a-Tab

Change your top tab folder to an end tab folder using this self adhesive heavy white label stock. Remove the backing sheet, align the crease with the top and bottom of your folder edge and wrap the convert-a-tab over the edge.

### Letter

#### SELF INSTALLED

MODEL NO.	DESCRIPTION	QUANTITY
4302-50	9" h white tag	box of 500
4302-01	4" h white tag	box of 250
4302-DPT	9 3/4" h Manila Double Ply	box of 100

TAB will no longer offer/quote the attaching of Compucolor or Filepak labels to the 4302-50 or 4302-01 convert-a-tabs (white). Both these models will continue to be stock items with immediate availability.



# Top/Side TAB Outguides

## Vinyl Outguides

Prevent lost files, lost information and search time by using outguides to identify folders removed from the system. Use a charge out slip to identify who has the file. Included is space to file trailing documents, allowing effective interfiling when the folder returns to file. Eliminate stacks of documents at your records desk to be filed.

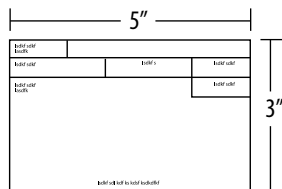
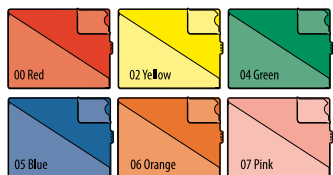

4368-00

### Charge-Out Slips

MODEL NO.	DESCRIPTION	QUANTITY
4368-00	Charge-Out Slips	box of 1000

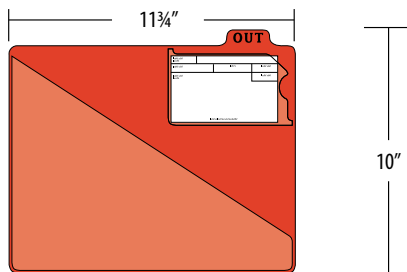

**Letter** 10" High x 11<sup>3</sup>/<sub>4</sub>" Wide

MODEL NO.	DESCRIPTION	QUANTITY
4370-00	Outguide	box of 50

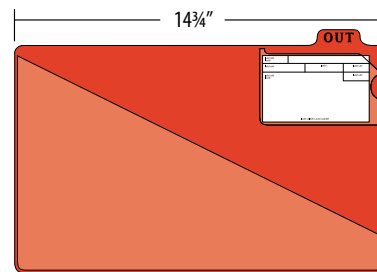

**Legal** 10" High x 14<sup>3</sup>/<sub>4</sub>" Wide

MODEL NO.	DESCRIPTION	QUANTITY
4388-00	Outguide	box of 50

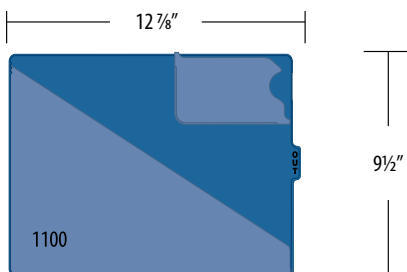

**Letter** 9<sup>1</sup>/<sub>2</sub>" High x 12<sup>3</sup>/<sub>4</sub>" Wide

MODEL NO.	DESCRIPTION	QUANTITY
1100-**	Middle Tab	box of 50

Replace \*\* with a color number

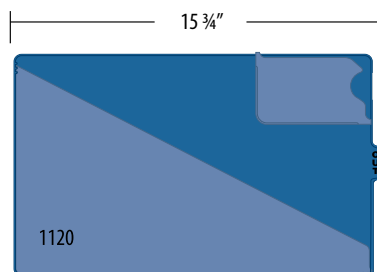

**Legal** 9<sup>1</sup>/<sub>2</sub>" High x 15<sup>3</sup>/<sub>4</sub>" Wide

MODEL NO.	DESCRIPTION	QUANTITY
1120-**	Middle Tab	box of 50

Replace \*\* with a color number

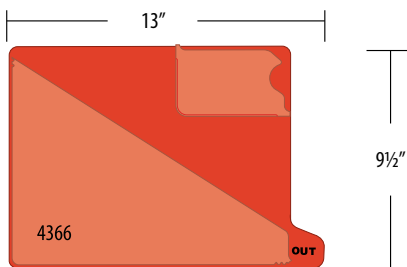

**Letter** 9<sup>1</sup>/<sub>2</sub>" High x 13" Wide

MODEL NO.	DESCRIPTION	QUANTITY
4366-**	Lower Tab	box of 50

Replace \*\* with a color number

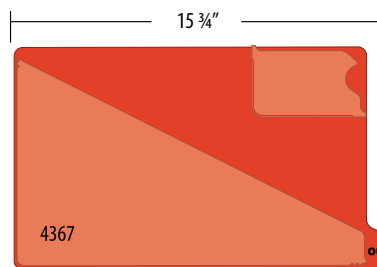

**Legal** 9<sup>1</sup>/<sub>2</sub>" High x 15<sup>3</sup>/<sub>4</sub>" Wide

MODEL NO.	DESCRIPTION	QUANTITY
4367-**	Lower Tab	box of 50

Replace \*\* with a color number

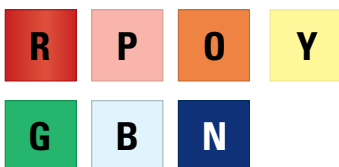

## AMES In-Sight Outguides

Outguides distinguish records or films that have not been returned. Print the out-of-file location of loaned items on the request slips and insert them into pockets for quick reference.

- Request slip pocket size: 3-1/4" x 5-1/2" (2-XOG-R is 3" x 7-3/4").
- Made of heavy-duty vinyl.
- See-through matte-finish pockets made from non-yellowing vinyl and stress-cut for durability.
- Select from 7 distinctive stock colors for letter size (additional colors available upon request). X-ray available in red only.

### Standard Tab 9" High x 13<sup>3</sup>/<sub>4</sub>"

MODEL NO.	DESCRIPTION	QUANTITY
ISOG-*	Lower Tab	box of 100

### Short Tab 9<sup>1</sup>/<sub>8</sub>" High x 12<sup>1</sup>/<sub>2</sub>"

MODEL NO.	DESCRIPTION	QUANTITY
ISOG-*ST	Lower Tab	box of 100

### X-ray Standard Tab 8<sup>1</sup>/<sub>4</sub>" High x 19<sup>1</sup>/<sub>2</sub>" (Red only)

MODEL NO.	DESCRIPTION	QUANTITY
2-XOG-R	Lower Tab	box of 50

Replace \* with desired color letter

# Accessories – Outguides

## AMES Center-Tab and Bottom-Tab Outguides

Choose either Bottom-Tab or Center-Tab Outguides for the best visibility on your shelves.

- Overall size, including tab: 9-1/2" x 12-3/4" (Center-Tab) 9-1/2" x 13" (Bottom-Tab)
- Made of rigid vinyl for long life.
- Frosted see-through pockets for documents and request slips.
- Tabs printed ("OUT") on both sides.
- Select from 8 distinctive colors (see item numbers in chart).

MODEL NO.	DESCRIPTION	COLOR	LBS./ROLL	QUANTITY
OG-FR-B	Centre-Tab	Dark Blue	8 lbs.	box of 50
OG-FR-O-BT	Bottom-Tab	Orange	8 lbs.	box of 50

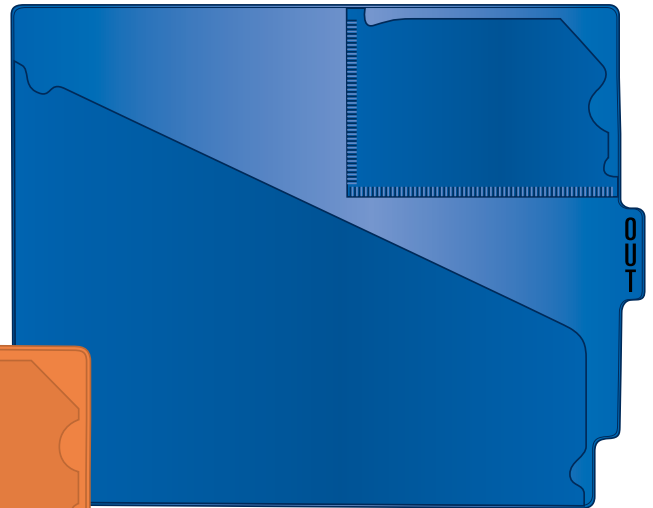

Center-Tab

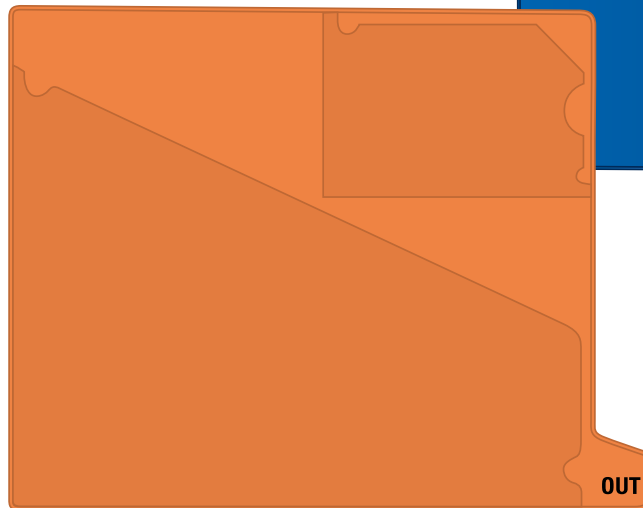

Bottom-Tab



## AMES Repair and Reinforcement Strips

AMES Repair and Reinforcement Strips allow you to reuse and extend the life of your folders.

- Made of clear, non-yellowing polyester.
- Permanent adhesive with split coated paper backing.
- Individually sheeted and shrink-wrapped in packages.

MODEL NO.	SIZE	LBS./ROLL	QUANTITY
L-A-RE-POLYS	2" x 11"	3 lbs.	pack of 500
L-A-RE-POLYS3	3" x 11"	4 lbs.	pack of 500

# TAB Terms & Policies



48 Hours is the usual time it takes for us to ship your stock supply purchase. Most are shipped the day after you place your order. Call TAB Express for delivery times on custom products and next day deliveries.



When calling TAB, your call be answered by a Filing Expert that can assist you with all your filing queries.



#### Manila, Color and Kraft Material:

11,14, and 18 point manila 10% Post-consumer waste (PCW)  
11 and 14 point color 30% Post-consumer waste (PCW)  
11 and 17 point Kraft 10% Post-consumer waste (PCW)

#### Pressboard Material:

Type II 60% recycled 30% Post-consumer waste (PCW)

**Red-Rope Expansion Pockets:** 30% Recycled, 10% PCW

**Our shipping cartons** consist of 65% virgin, 30% post-consumer waste, and 5% pre-consumer waste. Our internal folder boxes have recycled cellulose content of 65% post-consumer and 35% pre-consumer waste.

**All adhesive products** have a limited shelf life. We recommend that you purchase only the quantity that will be used within 12 months.

**TERMS:** Net 30 days from invoice and ship date. Prices are FOB TAB's facility in Mayville, Wisconsin and are subject to change without notice. Minimum Order Quantity: Made-To-Order products, printed products and labeled products have minimum quantities so orders below these minimums will also be up charged to meet the minimum quantity value. Split Box Shipments: Returns and cancellations must be pre-approved by calling 1-888-822-9777. Returns for standard product only must be processed within 30 days of shipment and will be assessed a 20% restocking fee. The merchandise must be shipped freight prepaid in its original packaging and be in resaleable condition. The merchandise will be inspected upon receipt.

#### Custom products are not returnable.

TAB reserves the right to correct any typographical errors.

**NOTE:** The colors represented in this catalog are as close as possible to actual TAB product colors within the limits of modern graphic processes. Minimum order \$100.00.



TAB accepts MasterCard, Visa, Discover and American Express cards for quick account set up.

**Over Run & Under Run Policy:** We attempt to ship exact quantities as ordered; however, we reserve the right to over-ship or under-ship a maximum of 10% on custom manufactured or printed items. On custom supplies requiring factory attached color-coded labels, the exact quantity of labels will be applied which frequently results in leftover custom folders. The excess folders will ship with the order with no label applied. Billing will reflect the quantity produced and shipped.

## Environmental Policy Statement

Our environment has become a subject of increasing importance in the world. TAB recognizes the importance of a sustainable earth and believes it is the responsibility of every person and every enterprise to set a standard for sustainability by assessing the impact of their business practices on our environment and implementing sound policies throughout their process and daily operations.

TAB has committed itself to reduce impacts on the environment and operating costs through pollution prevention activities. Through more proficient manufacturing methods and

investments in our facilities, we have seen reduction in material wastes, minimal air emissions and improvements in wastewater pre-treatment.

We consider the environmental impact of procedures throughout all facets of operation including, but not limited to purchasing, engineering, material handling, processing, manufacturing and transportation.

We incorporate best management practices into every decision-making process to reduce pollution to the minimum levels technically and economically feasible, while achieving

or exceeding compliance with all State and Federal regulations and increasing productivity, quality and value.

We continually renew the commitment to excellence and leadership in protecting the environment by using the basic principles of pollution prevention, waste minimization, waste elimination and recycling.

TAB's products are manufactured to meet and exceed environmental standards and provide a long useful life. Our suppliers are also selected according to these same friendly environmental practices

criteria. Our steel and paper suppliers use recyclable material content.

Our packaging department uses minimal amount of cardboards and whenever possible shrink wrap all the materials while ensuring that the products are safely protected when in transit to our customers.

TAB is committed to achieving a sustainable harmony with our global environment. Continuous commitments and improvements in providing adaptable workspace solutions with high-quality products are the foundations of our company.

# Index

MODEL NO.	PAGE	MODEL NO.	PAGE	MODEL NO.	PAGE	MODEL NO.	PAGE	MODEL NO.	PAGE
1000PKC100	16	1169-00	19	1249-00B	12	1309-**	41	2CFV-ST	7
1000PKE100	16	1172-**	19	1250-**	12	1317-00	4	2CFV15	7
1100-**	45	1174-**	20	1250-00	12	1318-00	4	2CFV15-ST	7
1102-00	4	1175-00	19	1251-**	12	1327-00	4	4302-01	44
1103-50	4	1176-00	19	1251-00	12	1328-00	4	4302-50	44
1104-00	4	1177-00	23	1252-00B	12	1334-**	10	4302-DPT	44
1105-50	4	1177-25	23	1253-00B	12	1335-**	10	4333-00	18
1106-**	10	1177-50	23	1254-**B	14	1336-**	10	4343-00	18
1108-00	15	1177-75	23	1254-00B	14	1337-**	10	4345-00	18
1108-01	15	1178-00	19	1255-**	14	1344-00	4	4348-00	18
1108-02	15	1179-00	19	1255-00	14	1345-00	4	4349-00	18
1111-00	8	1180-00	19	1256-**B	14	1346-00	4	4354-50	4
1112-00	8	1181-00	19	1256-00B	14	1347-00	4	4357-13	4
1114-00	8	1184-**	20	1257-**	14	1348-**	12	4366-**	45
1118-00	4	1187-**	21	1257-00	14	1348-00	12	4367-**	45
1119-00	8	1187-00	21	1258-00B	13	1349-**	12	4368-00	45
1120-**	21	1189-**	21	1259-00B	13	1349-00	12	4370-00	45
1122-00	11	1189-00	21	1268-00B	13	1350-**	12	4387-**	21
1123-00	4	1191-**	21	1269-00B	13	1350-00	12	4388-00	45
1126-**	5	1191-00	21	1274-DBL	40	1351-**	12	4397-**	21
1127-00	4	1193-**	21	1274-SGL	40	1351-00	12	4400-00	40
1128-00	4	1193-00	21	1277-*	34	1352-**B	13	4401-00	40
1129-00	5	1196-00	13	1277-50	34	1352-00B	13	5050-00	5
1130-00	22	1197-00	13	1278-*	30	1353-**B	13	5050-0T	5
1131-00	22	1211-**	11	1278-50	30	1353-00B	13	5100-00	5
1132-00	22	1212-**	11	1279-**	41	1354-**B	13	5100-0T	5
1133-00	22	1214-**	11	1279-50	41	1354-00B	13	5150-00	5
1139-00	20	1222-**	11	1280-*	36	1355-**B	13	5260-0T	5
1141-00	4	1235-**	12	1280-50	36	1355-00B	13		
1142-00	4	1235-00	12	1281-**	39	1379-**	21		
1149-00	15	1236-**	12	1281-50	39	1381-**	21		
1157-00	8	1236-00	12	1282-*	34	1389-00	30		
1157-C	8	1237-00B	12	1282-50	34	1390-00	30		
1157-L	8	1238-00B	12	1283-*	30	1394-00	30		
1157-R	8	1243-**B	13	1283-50	30	1396-00	30		
1158-00	8	1243-00B	13	1286-*	30	1397-00	30		
1158-C	8	1244-**B	13	1286-00	30	1398-00	30		
1158-L	8	1244-00B	13	1287-**	41	1401-00	30		
1158-R	8	1245-**B	13	1290-00	30	1406-**	10		
1159-00	17	1245-00B	13	13-411L	17	1426-**	10		
1160-00	17	1246-**B	13	1303-90	30	1454-**B	14		
1161-00	17	1246-00B	13	1306-**	38	1454-00B	14		
1162-**	9	1247-**B	13	1306-50	38	1456-**B	14		
1163-**	9	1247-00B	13	1307-*	38	1456-00B	14		
1166-**	20	1248-**B	13	1307-50	38	2-XOG-R	45		
1168-00	19	1248-00B	13	1308-**	38	2CFV	7		

MODEL NO.	PAGE	MODEL NO.	PAGE	MODEL NO.	PAGE	MODEL NO.	PAGE	MODEL NO.	PAGE
6304-00/CLCOM	44	CXIOE-MC	25	F5600	22	L-T-ALPHA	32	P	18
6307-00/CLCOM	44	CXIOE-NC	25	F5610	22	L178	33	PC-OE-MMM-250	25
6321-00/CLCOM	44	CXIOE-PL	25	F5650	22	L7600-*	39	PC-OE-NUC	25
6321-HA/CLCOM	44	CXIOE-PR	25	F5700	22	L7700-*	36	PC-OS-CT	25
6321-HA50/CLCOM	44	CXIOS-AN	25	F5750	22	L7701-*	31	PC-OS-MAM	25
6324-00/CLCOM	44	CXIOS-BN	25	F5755	22	L7704	31	PC-OS-MRI	25
6324-HA/CLCOM	44	CXIOS-HN	25	FAS-E-Z275	16	L8700-*	36	PMFLD	6
6324-HA50/CLCOM	44	CXIOS-MC	25	FAS-E-Z275A	16	L8706	36	PMFLD-O	6
6376-00/CLCOM	44	CXIOS-NC	25	FAS-PERM-1L	15	L8720-*	31	Q	18
6376-50/CLCOM	44	CXIOS-PL	25	FAS-PERM-2L	15	L8724	31	R	18
6378-00/CLCOM	44	DDS-FLD2	20	FAS-PRS-STK	15	L8800-**	41	SLH-BL	20
6379-00/CLCOM	44	DF737-**	40	FDL-MD	28	L8801-**	41	SLH-CA	20
6379-50/CLCOM	44	E=70001	16	FLB-ST	29	LI-FLD11	6	SLH-GR	20
6380-00/CLCOM	44	EZ-CMP-275	16	G	17	LI-FLD11-1P	6	SLH-PI	20
6381-00/CLCOM	44	EZ-EXT-275	16	H	17	LI-FLD15	6	SLH-PU	20
6384-00/CLCOM	44	EZ275RBIC	16	ISOG-*	45	LI-FLD15-2P	6	SLH-SC	20
6384-50/CLCOM	44	EZ275RBIM	16	ISOG-*ST	45	M	17	SLH-TA	20
6400-00/CLCOM	44	F	17	J	17	MCXIOE-MAM-250	25	TAB-DIV-ST1	29
6403-00/CLCOM	44	F-BL	11	J13514	22	MCXIOS-MAM-250	25	TAB-DIV-ST1-SE	29
6405-00/CLCOM	44	F-BR	11	J13516	22	MCXIOS-NUC-250	25	TAB-MR	28
6406-00/CLCOM	44	F-GR	11	J13524	22	MCXIOS-PL-250	25	TAB-VNA	28
6408-00/CLCOM	44	F-GY	11	J13526	22	MIDI-ST	24	TI52004	26
6408-50/CLCOM	44	F-OR	11	J13534	22	MIDI-ST-UNIV	24	TI52006	26
6410-00/CLCOM	44	F-PI	11	J13536	22	N=4333-00	18	TI52008	26
6412-00/CLCOM	44	F-PU	11	K	17	O=4348-00	18	TI54004	26
6413-00/CLCOM	44	F-RE	11	L	17	OCF-VNA	8	TI54006	26
6443-00/CLCOM	44	F-TA	11	L-A-**134RB	35	OCFV-1P	5	TI54008	26
6445-00/CLCOM	44	F-WH	11	L-A-**178	39	OCFV-2P	5	TI56004	26
6446-00/CLCOM	44	F-YE	11	L-A-**178RL	35	OCFV-A	5	TI56006	26
6447-00/CLCOM	44	F15-BL	11	L-A-**178RLP	35	OCFV-A15	5	TI56008	26
6453-00/CLCOM	44	F15-BR	11	L-A-**178RS	35	OCFV-EZ	6	XM1113D	25
700002	16	F15-GR	11	L-A-ALPHA	33	OCFV-EZ-15	6	XM1113DSS	25
ACXIOE-CT	25	F15-GY	11	L-A-DD**R134	42	OCFV-ST	7	XM1518D	25
ACXIOE-MRI	25	F15-OR	11	L-A-DD**R178	42	OCFV15-ST	7	XM1518DSS	25
B	15	F15-PI	11	L-A-M*	43	OCFVX	7		
CC-MIDI-ST	24	F15-PU	11	L-A-MY-*19	43	OCXE-DF-PL	23		
CD-MD	28	F15-RE	11	L-A-MY-*20	43	OCXE-DST	23		
CN1219-*	9	F15-TA	11	L-A-MY-*21	43	OCXE-DST-DP	24		
CN1229-*	9	F15-WH	11	L-A-MY-*22	43	OCXE-DUO-PL	24		
CN1259-*	9	F15-YE	11	L-A-MY-*23	43	OCXE-NST	23		
COCFV	8	F1832	22	L-A-RE-POLYS	46	OCXE-NST-DP	24		
CXE-DF-ST-DPKT	24	F1834	22	L-A-RE-POLYS3	46	OG-FR-B	46		
CXIOE-BN	25	F1842	22	L-A-TYR**	42	OG-FR-O-BT	46		
CXIOE-CH	25	F1844	22	L-J-**158	37	OPRS-DF	14		
CXIOE-CT	25	F1852	22	L-J-ALPHA	32	OPRS-ST	14		
CXIOE-MAM	25	F1854	22	L-T-**158	37	OPRS-STEZ 14	18		

# Easy Order Planner



It's easy! Check below for all your regular TAB products then call us at **1-888-822-9777** and you'll receive instant confirmation of stock and total order price. You can also mail to TAB EXPRESS, 605 Fourth St. Mayville, WI 53050 OR FAX to **1-800-304-4947**, or e-mail [cspaper@tab.com](mailto:cspaper@tab.com)

Now you can order online at [shoptab.com](http://shoptab.com)

## BILL TO

Customer No.: \_\_\_\_\_  
 Taxable:  Yes  No Tax Exempt No.: \_\_\_\_\_  
 Company: \_\_\_\_\_  
 Attention: \_\_\_\_\_  
 Address/P.O. Box: \_\_\_\_\_  
 City: \_\_\_\_\_ State: \_\_\_\_\_ Zip: \_\_\_\_\_  
 Office Phone: ( \_\_\_\_\_ ) \_\_\_\_\_  
 Email: \_\_\_\_\_

## SHIP TO

Company: \_\_\_\_\_  
 Attention: \_\_\_\_\_  
 Address/P.O. Box: \_\_\_\_\_  
 City: \_\_\_\_\_ State: \_\_\_\_\_ Zip: \_\_\_\_\_  
 If we have questions, who should we ask for? \_\_\_\_\_  
 Daytime Phone: ( \_\_\_\_\_ ) \_\_\_\_\_  
 Email: \_\_\_\_\_

Minimum order \$100.00



### Solid Color Folder

Indicate number of folders (100/box)  
 Letter Size \_\_\_\_\_ Legal Size \_\_\_\_\_  
 \_\_\_\_\_ 1106- \_\_\_\_\_ 1126- \_\_\_\_\_

- Fill in blank with code:**
- 00 Goldenrod
  - 01 White
  - 02 Blue
  - 03 Green
  - 04 Gray
  - 05 Canary
  - 06 Orange
  - 07 Pink
  - 08 Red
  - 09 Lavender

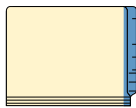

### Color End Tab Folder

Indicate number of folders (100/box)  
 Letter Size \_\_\_\_\_ Legal Size \_\_\_\_\_  
 \_\_\_\_\_ 1162- \_\_\_\_\_ 1163- \_\_\_\_\_

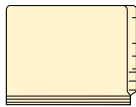

### Manila Folder

Letter Size \_\_\_\_\_ Legal Size \_\_\_\_\_  
 \_\_\_\_\_ 1103-50 11pt. \_\_\_\_\_ 1105-50 11pt.  
 \_\_\_\_\_ 1123 14pt. \_\_\_\_\_ 1127 14pt.



### Pressboard Folder

Letter Size \_\_\_\_\_ 1236 25pt. gray  
 \_\_\_\_\_ 1236- \_\_\_\_\_ 20pt.\*  
 Legal Size \_\_\_\_\_ 1251 25pt. gray  
 \_\_\_\_\_ 1251- \_\_\_\_\_ 20pt.\*

- Fill in blank with code:**  
 \*Refer to page 6 for available colors.

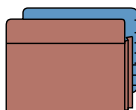

### Expansion Pockets

Letter / 1<sup>3</sup>/<sub>4</sub>" \_\_\_\_\_ 1187- \_\_\_\_\_ red front  
 \_\_\_\_\_ 1378- \_\_\_\_\_ color front\*  
 Letter / 3<sup>1</sup>/<sub>2</sub>" \_\_\_\_\_ 1189- \_\_\_\_\_ red front  
 \_\_\_\_\_ 1379- \_\_\_\_\_ color front\*  
 Legal / 1<sup>3</sup>/<sub>4</sub>" \_\_\_\_\_ 1191- \_\_\_\_\_ red front  
 \_\_\_\_\_ 1380- \_\_\_\_\_ color front\*  
 Legal / 3<sup>1</sup>/<sub>2</sub>" \_\_\_\_\_ 1193- \_\_\_\_\_ red front  
 \_\_\_\_\_ 1381- \_\_\_\_\_ color front\*

- Fill in blank with code:**
- 11 Manila
  - 50 Goldenrod
  - 51 White
  - 52 Blue
  - 53 Green
  - 54 Gray
  - 55 Canary
  - 56 Orange
  - 57 Pink
  - 58 Red
  - 59 Lavender

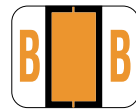

### Alphabetic Labels

Each box contains 500 of the same labels.  
 Indicate the quantity of boxes for each letter ordered.

\_\_\_\_\_ 1283-A \_\_\_\_\_ 1283-H \_\_\_\_\_ 1283-O \_\_\_\_\_ 1283-V  
 \_\_\_\_\_ 1283-B \_\_\_\_\_ 1283-I \_\_\_\_\_ 1283-P \_\_\_\_\_ 1283-W  
 \_\_\_\_\_ 1283-C \_\_\_\_\_ 1283-J \_\_\_\_\_ 1283-G \_\_\_\_\_ 1283-X  
 \_\_\_\_\_ 1283-D \_\_\_\_\_ 1283-K \_\_\_\_\_ 1283-R \_\_\_\_\_ 1283-Y  
 \_\_\_\_\_ 1283-E \_\_\_\_\_ 1283-L \_\_\_\_\_ 1283-S \_\_\_\_\_ 1283-Z  
 \_\_\_\_\_ 1283-F \_\_\_\_\_ 1283-M \_\_\_\_\_ 1283-T \_\_\_\_\_ 1283-Mc  
 \_\_\_\_\_ 1283-G \_\_\_\_\_ 1283-N \_\_\_\_\_ 1283-U \_\_\_\_\_ 1283-50

(Alpha set)



### Numeric Labels

Each box contains 500 of the same labels.

\_\_\_\_\_ 1282-01 \_\_\_\_\_ 1282-05 \_\_\_\_\_ 1282-09  
 \_\_\_\_\_ 1282-02 \_\_\_\_\_ 1282-06 \_\_\_\_\_ 1282-00  
 \_\_\_\_\_ 1282-03 \_\_\_\_\_ 1282-07 \_\_\_\_\_ 1282-50  
 \_\_\_\_\_ 1282-04 \_\_\_\_\_ 1282-08 (Complete set)



### Year Code Labels

Each box contains 500 of the same labels.

\_\_\_\_\_ 1287-17 \_\_\_\_\_ 1287-20 \_\_\_\_\_ 1287-23  
 \_\_\_\_\_ 1287-18 \_\_\_\_\_ 1287-21 \_\_\_\_\_ 1287-24  
 \_\_\_\_\_ 1287-19 \_\_\_\_\_ 1287-22 \_\_\_\_\_ 1287-25



### TABSTIK Labels

Each package contains 504 of the same labels.

\_\_\_\_\_ 1389 Dark Green \_\_\_\_\_ 1394 Red \_\_\_\_\_ 1397 Dark Blue  
 \_\_\_\_\_ 1390 White \_\_\_\_\_ 1396 Purple \_\_\_\_\_ 1398 Light Blue  
 \_\_\_\_\_ 1401 Tan



### Self-Adhesive Fasteners

Each box contains 100 fasteners.

\_\_\_\_\_ 1108 2" Self-adhesive fastener \_\_\_\_\_ 1149 2" Foamclip fastener

## USE THIS TO ORDER ADDITIONAL ITEMS NOT SHOWN:

Model No.	Color	Quantity	Description	Price Each	Total
Signature: _____				Order Total: _____	



# Order your year labels today!



# Easy online ordering!

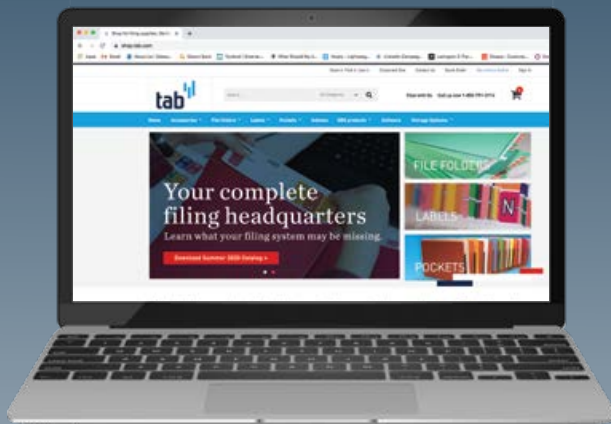

TAB2024

- Quick and simple sign-up
- Re-order past supplies with easy re-order feature
- Only a click away from the filing supplies you need

[shoptab.com](http://shoptab.com)



605 Fourth Street, Mayville, WI 53050

1.888.822.9777 [cspaper@tab.com](mailto:cspaper@tab.com) [shoptab.com](http://shoptab.com)